



RAFFREDDATORI DI LIQUIDO
DRY COOLERS
AERO-REFRIGERANTS
FLÜSSIGKEITS-RÜCKKÜHLER
ENFRIADORES DE LIQUIDO
СУХИЕ ГРАДИРНИ
SUCHE CHŁODNICE CIECZY

Check ongoing validity of certificate: www.eurovent-certification.com



PRODUCT INDEX



SAL Ø 500

60 61

SAL Ø 630

62 63



SAL Ø 800

64 65

▶ XHL Ø 950

New

66 69

XAL Ø 900-1000

70 73

▶ EHL Ø 950

New

74 77

EHL Ø 900 - EAL Ø 800-900

78 81



XDHL *Small Giants*

94 95



EHL *Giants*

102 103



XXL *Mega Giants*

110 111



Scambiatori di calore
per la refrigerazione industriale e commerciale,
per il condizionamento d'aria
e per le applicazioni industriali.

LU-VE S.p.A. è la capogruppo di **LU-VE** Group. Nel 1985, **LU-VE** S.p.A. acquisisce Contardo S.p.A., nata nel 1928. Nel 1986 inizia la sua attività produttiva.

LU-VE si è distinta e imposta presto grazie agli elevati standard qualitativi dei prodotti, alle nuove soluzioni studiate nei suoi laboratori e alla cura della qualità estetica (Belli fuori - Rivoluzionari dentro).

È LA PRIMA AZIENDA AL MONDO AD APPLICARE SOLUZIONI D'AVANGUARDIA ALLA REFRIGERAZIONE COMMERCIALE E INDUSTRIALE:

- LA TECNOLOGIA DEI TUBI RIGATI
- LA TECNOLOGIA DELLE SUPERFICI DI SCAMBIO SPECIALIZZATE
- LA CERTIFICAZIONE DELLE PRESTAZIONI
- MATERIALI E COLORI INNOVATIVI
- DESIGN AVANZATO.

Il successo sul mercato internazionale di **LU-VE**, deriva dalla sua politica di ricerca e sviluppo, dal rispetto dei principi fondamentali di salvaguardia dell'ambiente e dall'osservanza di rigorosi principi, etici e commerciali.

Nel 2000, **LU-VE** è stata la prima azienda in Europa a ottenere la prestigiosa certificazione **Eurovent "Certify All"**, per tutta la gamma dei suoi prodotti: aereoevaporatori, condensatori e dry coolers.

LU-VE e il Gruppo hanno introdotto un nuovo modo di concepire e realizzare i prodotti per la refrigerazione, il condizionamento e le applicazioni industriali, secondo tecnologie che sono poi diventate un riferimento costante per tutto il settore.



RAFFREDDATORI DI LIQUIDO

I raffreddatori di liquido sono utilizzati nei processi industriali (raffreddamento dell'acqua o di altri fluidi), per il condizionamento e la refrigerazione (raffreddamento dell'acqua e free cooling).

Grazie alle innovazioni sviluppate, brevettate e testate da LU-VE, i raffreddatori di liquido hanno le seguenti caratteristiche:

- bassi costi di manutenzione
- un funzionamento efficace in ogni condizione ambientale
- sono esenti dal rischio di incrostazioni e contaminazioni batteriologiche del liquido da raffreddare.

SCAMBIATORE DI CALORE

La straordinaria efficienza dello scambiatore di calore LU-VE deriva dalla combinazione ottimale di speciali alette di alluminio con tubi di rame.

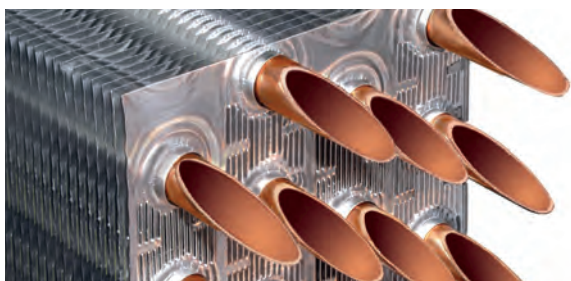

I vantaggi ottenuti sono:

- Potenza elevata con bassa portata d'aria.
- Basso assorbimento elettrico dei motori.
- Funzionamento silenzioso.

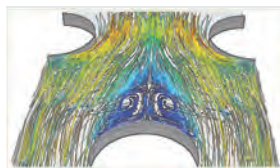

SOSPENSIONE BATTERIA

SAFETUBES SYSTEM

Il sistema di sospensione della batteria (SAFETUBES SYSTEM®, brevettato LU-VE), assicura la completa protezione dei tubi durante il trasporto, l'installazione e il funzionamento del raffreddatore di liquido.

SAFETUBES SYSTEM®
by LU-VE

ELETTROVENTILATORI

I motori (3 ~ 400 V 50 Hz) sono caratterizzati da:

- Alta efficienza e basso consumo.
- Lubrificati a vita e protezione termica incorporata.
- Bilanciamento dinamico e statico di motori e ventole.



CONVOGLIATORE

I bocchagli delle ventole ad alta efficienza eliminano il ricircolo dell'aria e riducono la rumorosità.

Ogni sezione di ventilazione è separata dalle altre (solo per SAL-XAL-EHL-EAL).

Le griglie sono conformi alle più severe norme di sicurezza per garantire la massima protezione.

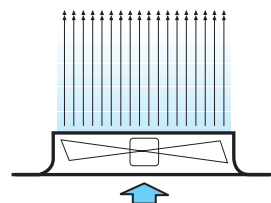

STRUTTURA

SMART (solo per EHL - XXLD)

La struttura brevettata, ampiamente sperimentata e collaudata su tavoli vibranti, consente grandi vantaggi:

- Maggiore rigidità del prodotto.
- Peso ridotto dell'apparecchio.
- Migliore e più uniforme circolazione dell'aria.
- Calo di prestazioni minimo in caso di fermo di un ventilatore.

DESIGN E MATERIALI

Le carenature sono in acciaio zincato, verniciate a polvere Epoxy-Polyester e resistenti alla corrosione. I collettori, le curve e le scatole di derivazione sono protetti.

CIRCUITI E ATTACCHI

Tutti i modelli sono disponibili con diversi circuiti, da selezionare secondo la portata del fluido refrigerante e le perdite di carico.

COLLAUDO

Le batterie sono collaudate a una pressione adeguata, dopo essere state accuratamente sgrassate ed essiccate con aria secca. Tutti i raffreddatori di liquido hanno una pressione massima di esercizio di 12 bar.

MANUTENZIONE

I convogliatori e le fiancate sono facilmente smontabili e l'accessibilità ai motori, alla batteria e alle scatole di derivazione è completa.

OPZIONI

- Motori "EC".
- Cablaggio motori alla scatola di derivazione.
- ALETTE ALUPAINT® in alluminio verniciato. (⊕)
- ALETTE CU in rame. (⊕)
- Flange.
- Protezione scambiatore di calore.
- Configurazioni speciali.
- Regolazione ventilatori (vedi pag. 5).
- Interruttori di servizio ventilatori (IS).
- Silenziatore Whisperer® (vedi pag. 5).
- Dry and Spray (vedi pag. 6).
- Water Spray System (vedi pag. 7).

(⊕) Per le potenze riferirsi a programma di calcolo Refriger®.

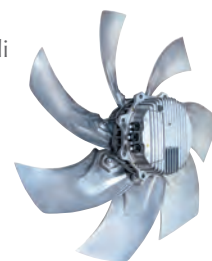



NORME

Gli apparecchi sono stati progettati e costruiti per poter essere incorporati in macchine come definito dalla Direttiva Macchine 2006/42/CE e successivi emendamenti.



- Direttiva 2014/29/CE e successivi emendamenti, Compatibilità elettromagnetica.
- Direttiva 2014/35/CE Bassa tensione.
- PED 2014/68/CE.

CERTIFICAZIONE EUROVENT

Tutte le gamme dei raffreddatori di liquido sono certificate EUROVENT

- Potenze (ENV 1048).
- Portate d'aria.
- Assorbimenti motori.
- Superfici esterne.
- Livelli pressione e potenza sonora (EN 13487).
- Perdite di carico.
- Classe energetica.



CARATTERISTICHE STANDARD DI POTENZA SECONDO ENV 1048

Le potenze dei raffreddatori di liquido sono provate alle seguenti condizioni:

Temperatura ambiente (TA)	25°C
Temperatura entrata fluido refrigerante (TWE)	40°C
Temperatura uscita fluido refrigerante (TWU)	35°C
Fluido refrigerante	acqua

CLASSE ENERGETICA

Classe	Consumo energia	R
A+	Estremamente basso	$R \geq 226$
A	Molto basso	$169 \leq R < 226$
B	Basso	$109 \leq R < 169$
C	Medio	$69 \leq R < 109$
D	Alto	$37 \leq R < 69$
E	Molto alto	$R < 37$

R = Potenza (AT 15K) / consumo energia motori.

ATTENZIONE

- Nel caso di utilizzo di acqua senza glicole etilenico, occorre essere sicuri che la temperatura ambiente sia sempre superiore a 0° C.
- Per evitare il pericolo di gelo durante il periodo di fermo, svuotare il raffreddatore insufflando aria a più riprese e introdurre glicole etilenico.
- Temperatura entrata fluido refrigerante ≤ 60 °C. (Versioni speciali per temperature > 60 °C).

SISTEMA GESTIONE ENERGIA

Il Sistema di Gestione per l'Energia LU-VE è conforme alla norma UNI CEI EN 50001:2011.



ASSICURAZIONE QUALITÀ

Il Sistema Qualità LU-VE, che include anche le procedure riguardanti la progettazione, le prove di laboratorio, i sistemi di produzione ed il controllo della qualità, ha ottenuto la certificazione UNI EN ISO 9001:2008.



GARANZIA 2 ANNI

Tutti i nostri prodotti sono costruiti con materiali di qualità e sottoposti a severi collaudi. Essi vengono pertanto garantiti per il periodo di due anni da qualsiasi difetto di costruzione.



Sono esclusi dalla garanzia i danni causati da fenomeni di corrosione. Eventuali parti od apparecchi riscontrati difettosi dovranno essere resi franco di porto al nostro Stabilimento, ove verranno controllati e, a nostro giudizio, riparati o sostituiti. Nessuna responsabilità viene da noi assunta per perdite o danni causati dall'uso o cattivo uso dei nostri prodotti. Ogni forma di garanzia decade qualora si riscontrasse che gli apparecchi sono stati sottoposti a cattivo uso o erroneamente installati. Ci riserviamo di apportare alla nostra produzione tutte le modifiche atte a migliorarne il rendimento o l'aspetto senza previa comunicazione e senza impegno per quanto riguarda la produzione precedente.



LU-VE TECHNOLOGY

	<p><i>Steel Protected Best Technology</i></p>	<p>Carenatura realizzata con acciaio zincato, verniciatura a polvere Epoxy-Polyester e resistente alla corrosione.</p>
	<p>SAFETUBES SYSTEM® by LU-VE</p>	<p>Il sistema brevettato LU-VE di sospensione della batteria SAFETUBES SYSTEM® esclude totalmente il contatto dei tubi con la struttura del condensatore o del raffreddatore di liquido e assicura la completa protezione dei tubi durante il trasporto, l'installazione e il funzionamento.</p>
		<p>La struttura SMART® brevettata e ampiamente sperimentata e collaudata su tavoli vibranti consente grandi vantaggi: maggiore rigidità del prodotto, peso ridotto dell'apparecchio, migliore e più uniforme circolazione dell'aria, calo di prestazioni minimo in caso di fermo di un ventilatore.</p>
		<p>I condensatori ventilati e i raffreddatori di liquido possono essere dotati dei nuovi ventilatori elettronici sviluppati con tecnologia EC, che consente di ridurre drasticamente i consumi energetici.</p>
		<p>Condensatori ventilati e raffreddatori di liquido con funzionamento silenzioso e consumi energia ridotti.</p>
		<p>Dry and Spray è la soluzione più avanzata per migliorare le prestazioni e minimizzare le dimensioni dei condensatori ventilati e dei raffreddatori di liquido di grande potenza.</p>
		<p>Water Spray System è la soluzione per massimizzare le prestazioni e minimizzare le dimensioni dei condensatori ventilati e dei raffreddatori di liquido di grande potenza.</p>



REGOLATORI ELETTRONICI DELLA VELOCITÀ DI ROTAZIONE DEI VENTILATORI

SCOPO

Mantenere la pressione di condensazione dei condensatori ventilati e la temperatura del liquido in uscita dei raffreddatori di liquido, entro valori prefissati, al variare delle condizioni operative, riducendo i consumi d'energia ed il livello sonoro dei ventilatori.

SP-SCU*

Regolatori elettronici basati sul principio del taglio di fase. Sono abbinabili all'interruttore generale **SF** e consentono di regolare in modo semplice apparecchi di piccola e media potenza.

AURT*

Regolatori elettronici basati sul principio del taglio di fase. Sono abbinabili ai quadri elettrici serie **AQE** e consentono di regolare in modo preciso e efficace apparecchi di media e grande potenza.

ARUS*

Regolatori elettronici realizzati con tecnologia basata sui gradini di tensione che consente una regolazione totalmente esente da rumori elettromagnetici.

AQE* Quadro elettrico - **SPR*** Sensore di pressione - **STE*** Sensore di temperatura - **SF*** Interruttore generale - **IS*** Interruttore di servizio.

*Vedere il manuale di istruzioni (www.luve.it).

SELEZIONE

Vedere **REFRIGER®**.



VENTILATORI CON MOTORI "EC"

(commutazione elettronica)

I condensatori ventilati e i raffreddatori di liquido possono essere dotati dei nuovi ventilatori elettronici sviluppati con tecnologia EC, che consentono di **ridurre drasticamente i consumi energetici**. I ventilatori, inoltre, sono dotati di un sistema integrato di regolazione che permette di modulare la velocità di rotazione a seconda delle esigenze, con un **comportamento acustico eccellente**. I ventilatori possono essere pilotati da un segnale 0 -10 Vdc, oppure da Bus (RS 485). I ventilatori sono auto-protetti. È possibile abbinare ai ventilatori EC una serie di quadri elettrici **ESB**, che ricevono un segnale esterno 0 -10 Vdc e lo trasferiscono ai ventilatori. In alternativa possono essere impiegati i quadri **ESR** che, grazie al regolatore ECP, controllano la pressione di condensazione mediante l'ausilio di una sonda di pressione (SPR), oppure la temperatura del liquido tramite una sonda di temperatura (STE).

Funzionalità del controllore ECP:

- modalità di regolazione proporzionale o PID (proporzionale, integrale, derivativa)
 - funzione Master/Slave (a cascata)
 - gestione di due segnali di ingresso
 - limiti notturni (riduzione rumorosità)
 - settaggio e modifica rapida del set point
 - controllo remoto di start/stop
 - collegamento tramite protocollo MODBUS (su richiesta).
- I quadri **ESJ** sono un ulteriore sviluppo. Gestiscono il segnale 0-10 Vdc come i modelli ESB e montano, oltre all'interruttore generale di linea, anche interruttori magnetotermici di protezione che comandano il singolo

ventilatore. Inoltre è previsto il cablaggio a morsetteria di ogni singolo contatto di allarme dei ventilatori previsti sull'apparecchio.

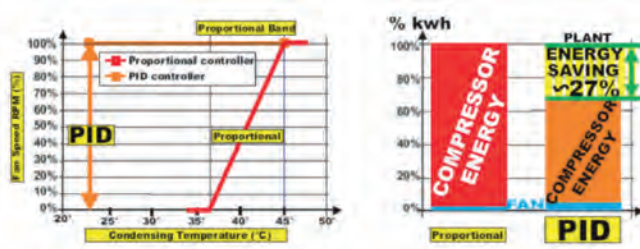

Una regolazione ancora più precisa è disponibile per mezzo dei quadri ESMC, basati sulla tecnologia ESJ e dotati dell'avanzatissimo regolatore **WMC2**, dotato di ulteriori funzioni utili per massimizzare l'efficienza dell'impianto:

- I ventilatori sono controllati tramite protocollo Modbus, che rende possibile la **gestione completa dei dati della macchina**, inclusi i dati di funzionamento per ciascun ventilatore, quali stato, consumi energetici, temperatura d'esercizio, allarmi, numero ore di funzionamento, massima velocità.

- Il regolatore **WMC2** consente di abilitare notevoli funzioni speciali per una **gestione molto precisa di condensatori e dry cooler**: regolazione P oppure PID, overspeed, by-pass, winter ON/OFF.

Il sistema di regolazione più semplice per i condensatori è il regolatore **CBG**, che consente di controllare la pressione di esercizio di condensatori piccoli.

SILENZIATORE - THE WHISPERER® PLUS

Il nuovo silenziatore compatto progettato e sperimentato nel laboratorio **LU-VE** assicura la drastica riduzione del livello di pressione sonora fino a **6,5 dB(A)**.

I benefici che si ottengono con i condensatori e con i raffreddatori di liquido realizzati con **THE WHISPERER® PLUS** sono i seguenti:

- risparmi energetici fino al 19%
- riduzione del livello di pressione sonora a parità di potenza
- aumento della potenza a parità di livello di pressione sonora
- riduzione degli ingombri degli apparecchi a parità di potenza e di livello di pressione sonora
- eliminazione dei ricircoli d'aria calda.



DRY and SPRAY

Per condensatori e raffreddatori di liquido di grande potenza.

NO

Health hazards (i.e. LEGIONELLA)
related to open warm
water reservoirs



LESS

Water consumption!
Energy!
Noise!
Pollution!
Operating cost!

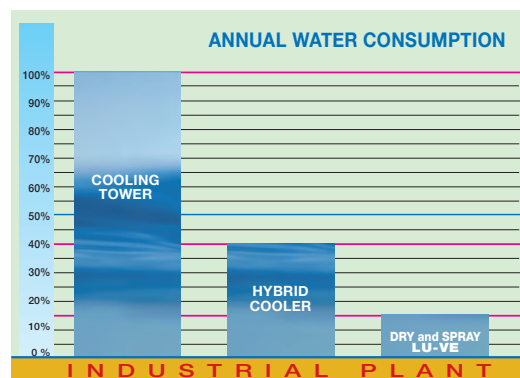
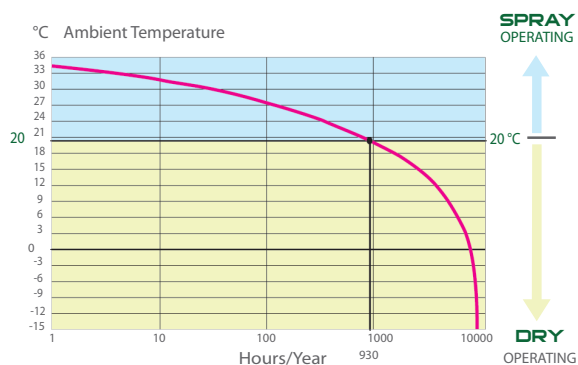

Annual water consumption for a generic industrial installation (on average from 3 to 10 times less than a traditional cooling tower)

Dopo un'intensa attività di ricerca finalizzata all'aumento delle prestazioni dello spray system è nata la nuova gamma "Dry and Spray". La straordinaria potenza dovuta alla particolare efficienza della nebulizzazione dell'acqua consente di realizzare un prodotto in grado di essere una valida alternativa alle tradizionali torri evaporative con importanti vantaggi.

FUNZIONAMENTO

I prodotti "DRY and SPRAY" funzionano come le tradizionali unità DRY fino a quando la temperatura dell'aria è sufficientemente bassa per mantenere la potenza di raffreddamento e la temperatura del liquido da raffreddare (o la pressione di condensazione) alle condizioni di progetto (funzionamento DRY). La temperatura di passaggio da funzionamento DRY a funzionamento SPRAY è una scelta progettuale e si colloca generalmente attorno ai 20°C. Questa tecnologia innovativa consente di ottenere, in funzione della temperatura del bulbo umido dell'aria ambiente, una temperatura del liquido raffreddato uguale o inferiore alla temperatura del bulbo secco dell'aria ambiente, con importanti vantaggi energetici. Un sofisticato sistema di controllo varia la velocità di rotazione dei ventilatori e la quantità di acqua nebulizzata secondo necessità.

VANTAGGI

L'impiego dei raffreddatori di liquido e dei condensatori "DRY and SPRAY" in alternativa alle tradizionali "torri evaporative" e "condensatori evaporativi" è caratterizzato dai seguenti importanti vantaggi:

- Il consumo di acqua nel funzionamento SPRAY è limitato a brevi periodi dell'anno. Per lunghi periodi dell'anno, durante il funzionamento DRY, non viene consumata acqua.
- L'assenza di bacinella sotto la batteria con acqua calda stagnante esclude la possibilità di concentrazioni di impurità nell'acqua e soprattutto i rischi di contaminazione dell'ambiente (**NO Legionella**).
- Funzionamento dell'impianto senza trascinarsi di gocce d'acqua nell'ambiente e senza formazione di antiestetici pennacchi.
- Bassi consumi di energia.
- Funzionamento silenzioso.
- Breve periodo di ammortamento dell'impianto.
- Possibilità di ottenere elevate potenze termiche in free cooling.

Vedere catalogo specifico per la qualità dell'acqua da nebulizzare.



Per condensatori e raffreddatori di liquido di grande potenza.



NO

Health hazards (i.e. LEGIONELLA)
related to open warm
water reservoirs



La soluzione migliore per massimizzare le prestazioni e minimizzare le dimensioni dei prodotti.

PRINCIPIO GENERALE

I dry coolers e i condensatori sono generalmente selezionati per funzionare correttamente al massimo carico termico con la massima temperatura ambiente. Queste gravose condizioni di funzionamento possono verificarsi tuttavia solo per un breve periodo dell'anno mentre per la rimanente parte dell'anno, con condizioni di funzionamento meno gravose, il prodotto risulta surdimensionato.

Per queste ragioni abbiamo progettato un nuovo prodotto che può essere selezionato per condizioni di funzionamento meno gravose ma che può aumentare le prestazioni al verificarsi di condizioni di funzionamento particolarmente gravose.

Il nuovo prodotto è ottenuto applicando ai dry coolers e ai condensatori tradizionali un sistema per spruzzare acqua finemente nebulizzata in direzione opposta a quella del flusso d'aria che attraversa le batterie.

Con questo sistema risulta possibile raffreddare l'aria che attraversa le batterie ottenendo un aumento della potenza dei dry coolers e dei condensatori.

L'impiego dello spray deve essere limitato a circa 200 ore/anno.

Vedere catalogo specifico per la qualità dell'acqua da nebulizzare.



LESS

Water consumption!
Energy!
Noise!
Pollution!
Operating cost!







Heat exchangers
for industrial and commercial refrigeration,
air conditioning
and industrial applications.



LU-VE S.p.A. is the holding company of **LU-VE** Group. In 1985 **LU-VE** S.p.A. acquired Contardo S.p.A., established in 1928. Production began in 1986.

LU-VE quickly made its mark thanks to high standards of quality, new solutions designed in its own laboratories and to the care taken with the appearance of its products. (Beautiful outside - Revolutionary inside).

LU-VE WAS THE FIRST COMPANY IN THE WORLD TO APPLY AVANT-GARDE SOLUTIONS TO COMMERCIAL AND INDUSTRIAL REFRIGERATION:

- GROOVED TUBE TECHNOLOGY
- SPECIALIZED HEAT EXCHANGE SURFACES
- CERTIFIED PERFORMANCE LEVELS
- INNOVATIVE MATERIALS AND COLOURS
- ADVANCED DESIGN.

The success of **LU-VE** in the international market stems from its research and development policy, its great respect for the environment and its rigorous ethical and commercial principles.

In 2000, **LU-VE** was the first company in Europe to attain the prestigious **Eurovent “Certify-All”** certification for the entire range of its products: unit coolers, condensers and dry coolers.

LU-VE and the Group have introduced new ways of conceiving and constructing products for refrigeration, air conditioning and industrial applications, creating new technologies which have then gone on to become the benchmark for the entire industry.



DRY COOLERS

Dry coolers are used in industrial processes (to cool water or other fluids) and for air conditioning and refrigeration (water cooling and free cooling).

Thanks to the innovations developed, patented and tested by LU-VE, the dry coolers produced by the company:

- are economical to run
- function efficiently in all environmental conditions
- do not present risks of scaling and bacteriological contamination of the liquid to be cooled.

HEAT EXCHANGER

The extraordinary efficiency of the LU-VE heat exchanger stems from the optimum combination of special aluminium fins with copper tubes.

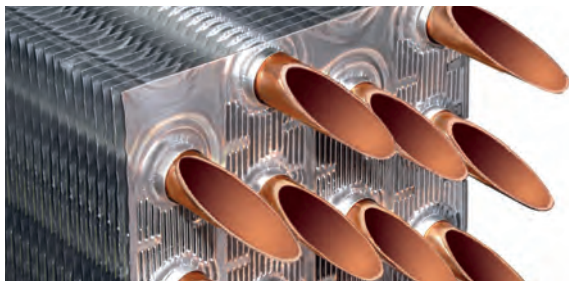

Advantages:

- High capacity with low air quantity.
- Low motor power draw.
- Quiet operation.

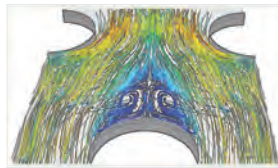

COIL SUSPENSION

SAFETUBES SYSTEM

The coil suspension system (SAFETUBES SYSTEM®, LU-VE patent) ensures that the tubes are completely protected during transportation, installation and operation of the dry cooler.

SAFETUBES SYSTEM®
by LU-VE

FAN MOTORS

Motors (3 ~ 400 V 50 Hz) feature:

- High efficiency and low consumption.
- Lifetime lubrication with incorporated heat protection.
- Dynamic and static balancing of motors and fans.



FAN SHROUD

The highly efficient design of the mouth of the fan shroud eliminates air recirculation and reduces noise.

Every fan section is separated from the others (only for SAL-XAL-EHL-EAL).

Fan guards conform to the most severe safety regulations in order to guarantee maximum protection.

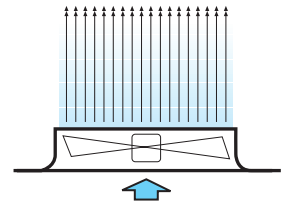

STRUCTURE

SMART (only for EHL - XXLD)

The patented structure, extensively tested on vibrating tables, provides important advantages:

- Greater rigidity.
- Reduced unit weight.
- Better and more uniform air distribution.
- Minimum decrease in performance in the event of one fan stopping.

DESIGN AND MATERIALS

Casings are made of corrosion-resistant galvanized steel with an epoxy-polyester powder coating.

The headers, return bends and junction boxes are all protected.

CIRCUITS AND CONNECTIONS

All models are available with different circuits, to be selected according to refrigerant fluid flow rate and pressure drops.

FINAL TESTING

Final testing is carried out at appropriate pressure after the coils have been carefully degreased and dried with dry air. All dry coolers have a maximum operational pressure of 12 bar.

MAINTENANCE

Fan shrouds and side panels can easily be removed to provide complete access to motors, coil and junction box.

OPTIONS

- "EC" motors.
- Motors wired to the junction box.
- ALUPAINT® in painted aluminium.^(*)
- CU in copper.^(*)
- Flanges.
- Heat exchanger protection.
- Special configurations.
- Fan speed regulation (see pag. 13).
- Fan Isolator Switches (IS) .
- Whisperer® Silencer (see pag. 13).
- Dry and Spray (see pag. 14).
- Water Spray System (see pag. 15).

^(*) (Refer to the Refrigerer® program for capacities).



STANDARDS

The products are provided for incorporation in machines as defined in the EC Machine Directive 2006/42/CE and subsequent modifications.



- Directive 2014/29/CE and subsequent modifications, Electromagnetic Compatibility.
- Directive 2014/35/CE Low tension.
- PED 2014/68/CE.

EUROVENT CERTIFICATION

The entire range of dry coolers is EUROVENT certified.

- Capacity (ENV 1048).
- Air quantity.
- Fan motor power draw.
- External surfaces.
- Sound pressure and power levels (EN 13487).
- Pressure drops.
- Energy class.



STANDARD CAPACITY SPECIFICATIONS TO ENV 1048

The capacities of the dry coolers are tested under the following conditions:

Ambient temperature (TA)	25°C
Refrigerant fluid inlet temperature (TWE)	40°C
Refrigerant fluid outlet temperature (TWU)	35°C
Refrigerant fluid	water

ENERGY CLASS

Class	Energy consumption	R
A+	Extremely low	$R \geq 226$
A	Very low	$169 \leq R < 226$
B	Low	$109 \leq R < 169$
C	Medium	$69 \leq R < 109$
D	High	$37 \leq R < 69$
E	Very high	$R < 37$

R = Capacity (AT 15K) / motor power consumption.

CAUTION

- If water without glycol is used, the ambient temperature must always be above 0 °C.
- To prevent freezing during standstill, drain off the dry cooler by blowing air through several times and then introduce glycol.
- Refrigerant fluid inlet temperature ≤ 60 °C. (Special versions for temperature >60 °C).

ENERGY MANAGEMENT SYSTEM

The LU-VE energy management system conforms to UNI CEI EN 50001:2011.



QUALITY ASSURANCE

LU-VE is a certificated company to UNI EN ISO 9001:2008, which is the most important Quality Assurance qualification, covering Development, Testing, Production method and Inspection procedures.



2 YEAR GUARANTEE

All our products are manufactured from high quality materials and undergo severe final tests. They are therefore guaranteed against any construction defect for a period of two years.



Damage caused by corrosive agents is excluded. Components or units found to be defective must be returned to our factory with prepaid freight where they will be checked and, depending on our judgement, replaced or repaired. We take no responsibility for leaks or damage caused by the use or misuse of our products. No guarantee is granted in the event of misuse or incorrect installation of the products. We reserve the right to make modifications in order to improve the performance or appearance of our products at any time without notice and without any obligation to previous production.



LU-VE TECHNOLOGY

	<p><i>Steel Protected Best Technology</i></p>	<p>Galvanized steel casing with corrosion-resistant epoxy-polyester powder coating.</p>
	<p>SAFETUBES SYSTEM® by LU-VE</p>	<p>The LU-VE-patented coil suspension SAFETUBES SYSTEM® completely eliminates contact between tube and condenser or dry cooler structure, providing full protection for the coil tubes during transport, installation and operation.</p>
		<p>The patented SMART® structure, exhaustively tested on vibrating platforms, provides many advantages such as greater product rigidity, reduced unit weight, better and more uniform air circulation and minimum performance loss if one motor should stop.</p>
		<p>Air-cooled condensers and dry coolers can be fitted with new electronic fans developed using EC technology, dramatically reducing energy consumption.</p>
		<p>Air cooled condensers and dry coolers with low noise operation and low energy consumption.</p>
		<p>Dry and Spray is the most advanced solution to improve performance and minimize dimensions of large-capacity air-cooled condensers and dry coolers.</p>
		<p>Water Spray System is the solution to maximize performance and minimize dimensions of large-capacity air-cooled condensers and dry coolers.</p>

ELECTRONIC FAN SPEED CONTROLLERS

PURPOSE

The fan speed controller has the ability to maintain the condensing pressures of the air cooled condensers and to maintain the fluid outlet temperature of the dry coolers within prefixed values, for any given load on the unit, whilst at the same time reducing power consumption and noise levels of the fan motors.

SP-SCU*

Electronic fan speed controllers based on cut phase principle. They can be coupled with the main switch **SF** and allow low and medium capacity units to be controlled easily.

AURT*

Electronic fan speed controllers based on cut phase principle. They can be coupled with **AQE** electrical panel, allowing medium and high capacity units to be controlled effectively and precisely.

ARUS*

Electronic fan speed controllers based on voltage steps; this technology allows regulation which is completely free from electromagnetic noise.

AQE* Electrical panel - **SPR*** Pressure sensor - **STE*** Temperature sensor - **SF*** Main switch - **IS*** Isolator switch.

*See *Instruction Manual (www.luve.it)*.

SELECTION

See **REFRIGER®**.



FANS WITH "EC" MOTORS

(electronic commutation)

The air-cooled condensers and dry coolers can be fitted with the new electronic fans developed using EC technology, **dramatically reducing energy consumption**.

The fans are also fitted with a control system which can modulate the rotation speed depending on requirements, with **excellent acoustic performance**. The fans can be driven by a 0-10 Vdc signal or by BUS (RS 485). The fans are self-protected. These fans can also be combined with a series of **ESB** electrical panels which receive an external 0-10 Vdc signal and transfer it to the fans. Alternatively, **ESR** electrical panels can be used; these, thanks to the ECP controller, regulate the condensing pressure with the aid of a pressure sensor (SPR), or the liquid temperature by means of a temperature sensor (STE).

Functions of the ECP controller include:

- proportional or PID (proportional-integral-derivative) control
- master/slave function (cascade)
- management of two input signals
- night limit (reduced noise)
- rapid modification and setting of the set point
- remote control of start/stop
- connection through MODBUS protocol (on request).

The **ESJ** electrical panels are a further development. They manage the 0-10 Vdc signal in the same way as the ESB model and are fitted with (in addition to the main line switch) magneto-thermic protection switches which drive individual fans.

There is also terminal strip wiring for each individual alarm contact of the fans on the unit.

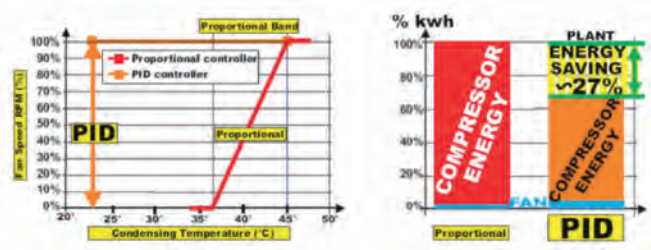

Even more precise regulation is available through the use of the **ESMC electrical panels**, based on **ESJ** technology and fitted with the highly advanced **WMC2** controller with additional useful functions to maximise the efficiency of the system:

- The fans are controlled via MODBUS protocol which makes possible the **complete management of the machine data** including function data for each fan, such as status, energy consumption, working temperature, alarms, working hours and maximum speed.

- The **WMC2** controller permits the activation of many important special functions for the **extremely precise management of condensers and dry coolers**: P or PID regulation, overspeed, by-pass, winter ON/OFF.

The simplest control system for condensers is the **CBG** controller, for the regulation of working pressure of small condensers.

SILENCER - THE WHISPERER® PLUS

The new compact silencer, designed and tested in the **LU-VE** laboratories, dramatically reduces sound pressure level up to **6.5 dB(A)**.

Condensers and dry coolers with **THE WHISPERER® PLUS** provide the following benefits:

- energy savings up to 19%
- reduction of sound pressure level at equal capacity
- increase of capacity at equal sound pressure level
- smaller unit footprint at equal capacity and sound pressure level
- elimination of warm air recirculation.



DRY and SPRAY

For large capacity air cooled condensers and dry coolers.

NO

Health hazards (i.e. LEGIONELLA) related to open warm water reservoirs

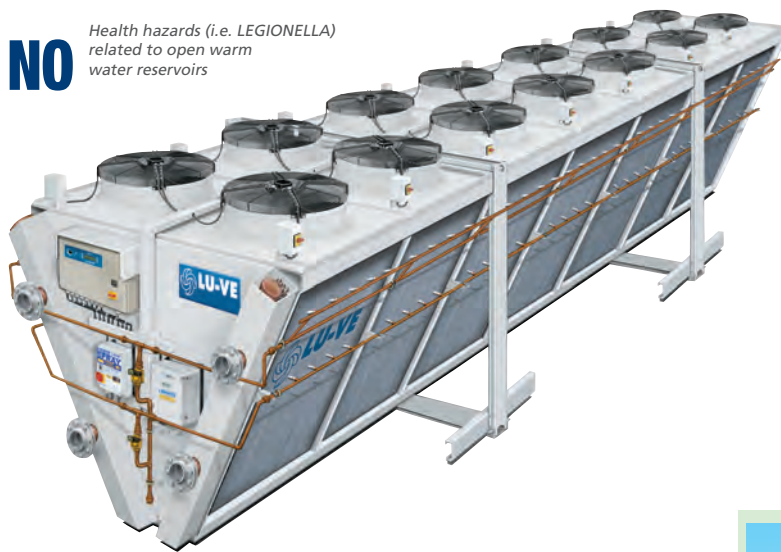

LESS

Water consumption!
Energy!
Noise!
Pollution!
Operating cost!

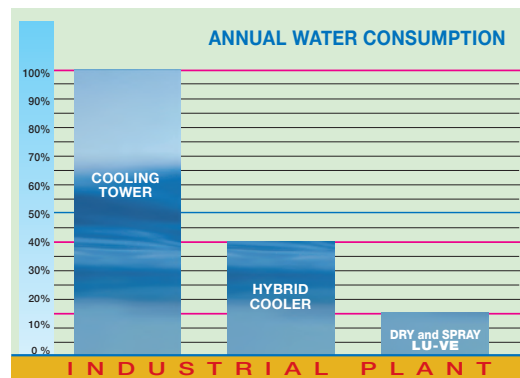
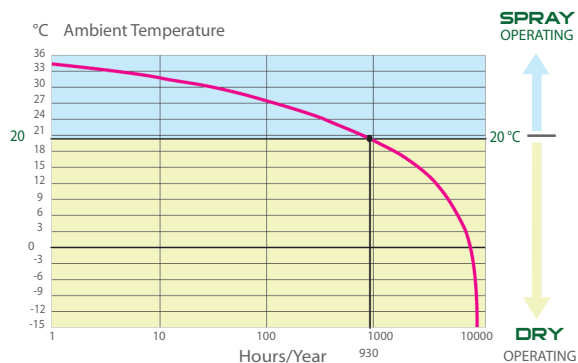

Annual water consumption for a generic industrial installation (on average from 3 to 10 times less than a traditional cooling tower)

After exhaustive research into increasing the spray system capacities, the new "Dry and Spray" range was created.

The extraordinary performance levels due to highly efficient water nebulization mean that this product is an alternative to traditional cooling towers with additional important advantages.

OPERATION

The "DRY and SPRAY" products work as traditional dry units until the ambient air temperature is low enough to maintain the cooling capacity and the coolant temperature (or condensing pressure) at the planned conditions (DRY operation).

The temperature passage from DRY to SPRAY operation is a planning choice and usually is about 20°C.

This innovative technology also enables, depending on the ambient air wet bulb temperature, a coolant temperature equal to or lower than the dry bulb temperature of ambient air with significant energy advantages.

A sophisticated control system adjusts the speed of the fans and the nebulised water capacity as required.

ADVANTAGES

The use of "DRY and SPRAY" liquid coolers and condenser instead of traditional "evaporative cooling towers" and "evaporative condensers" is characterized by the following important advantages:

- Water consumption in SPRAY operation mode is limited to short periods per year. For long periods of the year during DRY operation mode no water is used.
- There is no tray containing warm stagnant water under the coil, thus excluding any chance of impure water concentration and the general risk of environmental contamination (**NO Legionella**).
- Plant operating without water droplet drag-out to the environment and the formation of ugly vapour plumes.
- Low energy consumption.
- Low noise operation.
- Short plant redemption period.
- High thermal capacity can be obtained by free cooling.

Refer to specific catalogue for nebulised water quality.

WATER SPRAY SYSTEM

For condensers and dry coolers of great power.



NO

Health hazards (i.e. LEGIONELLA) related to open warm water reservoirs



The best solution for maximizing performance and minimizing product dimensions.

GENERAL PRINCIPLE

Dry coolers and condensers are generally selected in order to perform correctly at the maximum load with the maximum ambient temperature.

These difficult conditions happen only for a very short period of the year, whereas in the rest of the year, under less difficult working conditions, the product is oversized.

For this reason we have designed a new product which can be selected for less difficult working conditions, but the performance levels increase in event of particularly difficult conditions.

The new product is made up of a water spray system mounted on standard condensers and dry coolers which sprays finely nebulized water in the opposite direction to the air flow crossing the coils.

In this way it is possible to cool the air entering the coils thus increasing the capacity of dry coolers and condensers.

Use of the spray should be limited to about 200 hours per year.

Refer to specific catalogue for nebulised water quality.



LESS

Water consumption!
Energy!
Noise!
Pollution!
Operating cost!







Echangeurs de chaleur
pour la réfrigération industrielle et commerciale,
la climatisation
et les applications industrielles.

LU-VE S.p.A. est à la tête de **LU-VE** Group. En 1985, Contardo S.p.A. (fondée en 1928) est rachetée par **LU-VE** S.p.A. qui en 1986 débute sa propre activité.

LU-VE s'est distinguée et imposée rapidement grâce à des produits de qualité, à des solutions innovantes élaborées dans ses laboratoires et à la qualité esthétique (Beaux à l'extérieur, Révolutionnaires à l'intérieur).

ELLE FUT LA PREMIÈRE SOCIÉTÉ AU MONDE À APPLIQUER À LA RÉFRIGÉRATION COMMERCIALE ET INDUSTRIELLE DES INNOVATIONS TELLES QUE:

- TECHNOLOGIE DES TUBES RAINURÉS
- TECHNOLOGIE DES SURFACES D'ÉCHANGE SPÉCIALISÉES
- CERTIFICATION DES PERFORMANCES
- MATÉRIAUX ET COULEURS INNOVANTS
- DESIGN NOVATEUR.

Le succès de **LU-VE** sur le marché international est le fruit de sa politique de recherche et développement, de son respect pour l'environnement, et de l'observation de principes rigoureux, aussi bien esthétiques que commerciaux. En 2000, **LU-VE** a été la première société en Europe à obtenir pour l'ensemble de ses produits (évaporateurs, condenseurs et dry coolers) une certification prestigieuse: **Eurovent "Certify-All"**.

LU-VE et l'ensemble du Groupe ont instauré une nouvelle façon de concevoir et de fabriquer les produits de réfrigération, de climatisation et d'applications industrielles, suivant des procédés qui sont devenus depuis une référence constante pour le secteur.



Les aéroréfrigérants sont utilisés dans les installations industrielles (refroidissement d'eau ou d'autres fluides), pour la climatisation et la réfrigération (refroidissement d'eau ou free cooling). Grâce aux innovations développées, brevetées et testées par LU-VE, nos aéroréfrigérants:

- ont un faible coût de fonctionnement
- sont efficaces quelles que soient les conditions de fonctionnement
- ne présentent pas de risques d'encrassement ni de contamination bactérienne du liquide à refroidir.

ECHANGEUR DE CHALEUR

L'efficacité de l'échangeur de chaleur LU-VE résulte de la combinaison optimale d'ailettes spéciales en aluminium et de tubes cuivre.

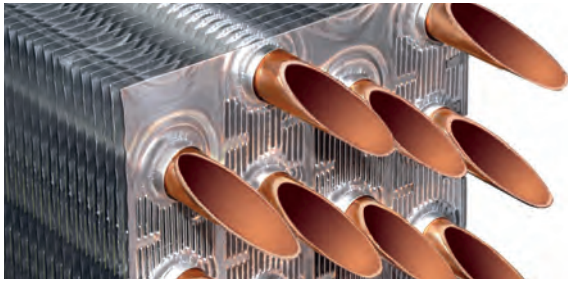

Les avantages obtenus sont:

- Forte puissance, faible portée d'air.
- Faible consommation électrique des moteurs.
- Fonctionnement silencieux.

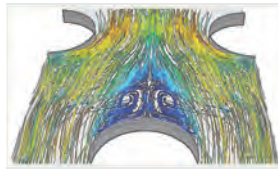

SUSPENSION DE LA BATTERIE

SAFETUBES SYSTEM

Le système de suspension de la batterie (Safetubes System, breveté par LU-VE) assure une protection totale des tubes pendant le transport, l'installation et le fonctionnement de l'aéroréfrigérant.



ELECTRO-VENTILATEURS

Les moteurs (3 ~ 400 V 50 Hz) sont:

- Extrêmement performants et peu énergivores.
- Lubrifiés à vie et bénéficient d'une protection thermique intégrée.
- Équilibrés dynamiquement et statiquement tant pour les moteurs que pour les hélices.



DIFFUSEUR

Les diffuseurs des hélices éliminent la recirculation d'air et réduisent le bruit. Chaque section de ventilation est séparée des autres (seulement pour SAL-XAL-EHL-EAL).

Les grilles sont conformes aux normes de sécurité les plus sévères pour garantir la meilleure protection.

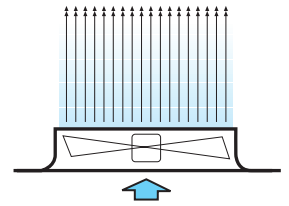

STRUCTURE

SMART (seulement pour EHL - XXL).

La structure brevetée, testée et éprouvée sur tables vibrantes offre d'énormes avantages:

- Meilleure rigidité.
- Appareil plus léger.
- Circulation d'air meilleure et plus uniforme.
- Les performances ne baissent que légèrement en cas d'arrêt d'un ventilateur.

DESIGN ET MATERIAUX

Les carrosseries sont en acier galvanisé, revêtues d'une protection par poudrage électrostatique époxy-polyester résistant à la corrosion. Les collecteurs, les crosses et les boîtes de dérivation sont protégés.

CIRCUITS ET RACCORDEMENTS

Tous les modèles sont disponibles en différents circuitages, à sélectionner selon le débit du fluide réfrigérant et les pertes de charge.

TEST

Les batteries sont testées avec une pression adéquate, après avoir été soigneusement dégraissées et séchées à l'air sec. Tous les aéroréfrigérants ont une pression maximale d'exercice de 12 bars.

MAINTENANCE

Les diffuseurs et les carrosseries latérales sont facilement démontables et l'accessibilité aux moteurs, aux batteries et aux boîtiers de dérivation est totale.

OPTIONS

- Moteurs "EC".
- Câblage des moteurs et des boîtiers de dérivation.
- Alupaint: aluminium peint (PC x 0,97).
- Cuivre (PC x 1,03).
- Brides.
- Protection échangeur de chaleur.
- Configurations spéciales.
- Régulation ventilateurs (voir page 21).
- Interrupteur de service ventilateurs (IS).
- Silencieux Whisperer® (voir page 21).
- Dry and Spray (voir page 22).
- Water Spray System (voir page 23).

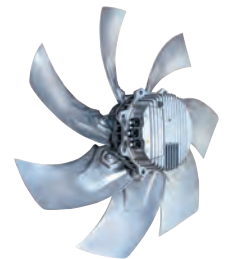

(*) (Pour les puissances, voir le logiciel de calcul Refriger®).

NORMES

Les appareils ont été conçus et fabriqués pour pouvoir être incorporés aux machines, tel que défini dans la Directive Machines 2006/42/CE et amendements successifs.



- Directive 2014/29/CE et amendements successifs, Compatibilité électromagnétique.
- Directive 2014/35/CE Basse tension.
- PED 2014/68/CE.

EUROVENT CERTIFICATION

Toutes les gammes d'aéroréfrigérants sont certifiées EUROVENT.

- Puissances (ENV 1048).
- Débit d'air.
- Consommation des moteurs.
- Surfaces externes.
- Niveaux de pression et puissance sonore (EN 13487).
- Pertes de charge.
- Classes énergétiques.



DÉFINITION DES PUISSANCES SELON ENV 1048

Les puissances des aéroréfrigérants sont testées dans les conditions suivantes:

Température ambiante (TA)	25°C
Température d'entrée fluide réfrigérant (TWE)	40°C
Température de sortie fluide réfrigérant (TWU)	35°C
Fluide réfrigérant	eau

CLASSE ÉNERGÉTIQUE

Classe	Consommation d'énergie	R
A+	Extrêmement basse	$R \geq 226$
A	Très basse	$169 \leq R < 226$
B	Basse	$109 \leq R < 169$
C	Moyenne	$69 \leq R < 109$
D	Elevée	$37 \leq R < 69$
E	Très élevée	$R < 37$

R = Puissance (ΔT 15K) / consommation énergie moteurs.

ATTENTION

- En cas d'utilisation d'eau sans glycol éthylène, il faut être sûr que la température ambiante sera en permanence supérieure à 0 °C.
- Pour éviter le risque de gel durant l'arrêt, vidanger l'aéroréfrigérant en insufflant de l'air à plusieurs reprises, puis introduire le glycol éthylène.
- Température d'entrée de fluide réfrigérant ≤ 60 °C (versions spéciales pour températures supérieures à 60 °C).

SYSTÈME DE GESTION DE L'ÉNERGIE

Le système de gestion de l'énergie de LU-VE est conforme à la norme UNI CEI EN 50001:2011.



ASSURANCE QUALITÉ

Le Système Assurance Qualité de LU-VE qui inclut toutes les procédures depuis l'étude des produits, les essais, l'ensemble du système de production et le système de contrôle qualité a obtenu la certification UNI EN ISO9001:2008.



GARANTIE 2 ANS

Tous nos produits sont fabriqués avec des matériaux de qualité et soumis à des tests sévères. Ils sont par conséquent garantis pour une période de deux années contre tout vice de fabrication.



Sont exclus de la garantie les dommages résultant de la corrosion. Les pièces ou appareils éventuellement défectueux devront nous être renvoyés sans frais, afin que nous puissions les analyser et juger s'ils doivent être réparés ou échangés. Nous ne saurions être tenus pour responsables de pertes ou de dommages résultant de l'usure ou d'une mauvaise utilisation de nos produits.

La garantie est caduque si les appareils ont été soumis à une utilisation incorrecte ou mal installés. Nous nous réservons le droit d'apporter à nos produits des modifications ou améliorations sans information préalable, ni obligation quant aux fabrications antérieures.



LU-VE TECHNOLOGY

	<p><i>Steel Protected Best Technology</i></p>	<p>Carrosserie en acier galvanisé, peinte par poudrage époxy-polyester, résistante à la corrosion.</p>
	<p>SAFETUBES SYSTEM® by LU-VE</p>	<p>Le système de suspension de la batterie SAFETUBES SYSTEM®, breveté LU-VE, empêche tout contact des tubes avec la structure du condenseur, et assure une protection totale des tubes pendant le transport, l'installation et le fonctionnement.</p>
		<p>La structure SMART®, brevetée et testée sur tables vibrantes offre de nombreux avantages: meilleure rigidité, poids réduit, circulation d'air meilleure et plus uniforme, perte d'efficacité moindre en cas d'arrêt d'un ventilateur.</p>
		<p>Les condenseurs à air et aéroréfrigérants peuvent être équipés de nouveaux ventilateurs électroniques EC, qui permettent de réduire de façon significative les consommations d'énergie.</p>
		<p>Condenseurs à air et aéroréfrigérants à fonctionnement silencieux et consommation d'énergie réduites.</p>
		<p>Dry and Spray est la solution la plus innovante pour améliorer les performances et réduire les dimensions des condenseurs à air et des aéroréfrigérants de fortes puissances.</p>
		<p>Water Spray System permet d'améliorer les performances et de réduire les dimensions des condenseurs à air et aéroréfrigérants de fortes puissances.</p>

RÉGULATEURS ÉLECTRONIQUES DE VITESSE DE ROTATION DES VENTILATEURS

OBJECTIF

Maintenir la pression de condensation des condenseurs à air et la température du liquide en sortie du refroidisseur de liquide dans des valeurs pré-définies, en fonction des conditions de fonctionnement, pour réduire les consommations d'énergie et le niveau sonore des ventilateurs.

SP-SCU*

Régulateurs électroniques fonctionnant suivant le principe du hachage de phases. Ils peuvent être couplés au sectionneur général **SF** et permettent de réguler de façon simple les appareils de petites et moyennes puissances.

AURT*

Régulateurs électroniques fonctionnant sur le principe du hachage de phases. Ils peuvent être couplés aux coffrets électroniques **AQE** et permettent de réguler de façon précise et efficace les appareils de moyennes et fortes puissances.

ARUS*

Régulateurs électroniques conçus selon la technologie des étages de tension, qui permet une régulation totalement exempte de bruits électromagnétiques.

AQE* Coffret électrique de puissance - **SPR*** Sonde de pression - **STE*** Sonde de température - **SF*** Sectionneur général - **IS*** Sectionneur de service.

*Voir le Manuel d'instructions (www.luve.it).

SELECTION

Voir **REFRIGER®**.



MOTO-VENTILATEURS "EC"

(Electronic Commutation)

Afin de **réduire leur consommation d'énergie**, les condenseurs à air et les dry coolers peuvent être équipés de nouveaux moto-ventilateurs «EC». Les moto-ventilateurs sont équipés d'un système de contrôle, qui adapte la vitesse de rotation en fonction des besoins, **réduisant ainsi la puissance absorbée et le niveau sonore**. Les ventilateurs peuvent être gérés par un signal 0-10 Vdc par BUS (RS 485). Ils sont auto-protégés. Ces ventilateurs peuvent être couplés à des coffrets électriques **ESB** qui reçoivent un signal externe 0-10 Vdc et le transfèrent aux ventilateurs. On peut également utiliser des coffrets électriques **ESR**, qui grâce au contrôleur ECP, régulent la pression de condensation à l'aide d'une sonde de pression (SPR) ou la température de liquide grâce à une sonde de température (STE).

Le contrôleur ECP offre également les fonctions suivantes:

- Contrôle proportionnel ou PID (Proportionnel Intégral Dérivé)
- Fonction maître/esclave (cascade)
- Gestion de deux signaux d'entrée
- Fonctionnement de nuit (niveau sonore réduit)
- Modification et paramétrage du point de consigne
- Contrôle marche/arrêt à distance
- Connection par MODBUS (sur demande).

Les coffrets **ESJ** sont encore plus performants. Ils gèrent le signal 0-10Vdc de la même manière que le coffret ESB et sont équipés (en plus de l'interrupteur général) d'une

protection magnéto-thermique, qui gère chaque moteur indépendamment. Il existe aussi un bornier où sont reportés individuellement tous les contacts de départ des ventilateurs.

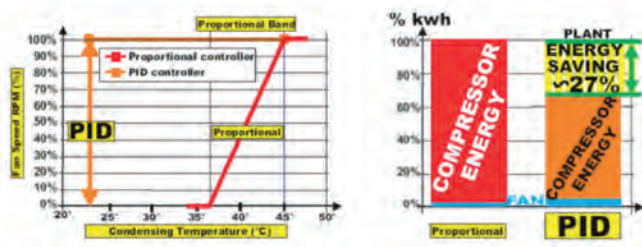

Une régulation encore plus fine est possible, en utilisant le coffret **ESMC**, qui fonctionne selon la technologie **ESJ**, et est équipé d'un contrôleur **WMC2** très sophistiqué, offrant deux fonctions supplémentaires pour rendre le système encore plus performant:

- Les ventilateurs sont contrôlés par MODBUS, ce qui permet de **gérer totalement les données de l'appareil**, y compris les données de chaque ventilateur, telles que: état, consommation d'énergie, température de fonctionnement, alarmes, heures de fonctionnement, vitesse maximale.
- Le contrôleur **WMC2** permet une **gestion extrêmement précise des condenseurs et dry coolers**: régulation P ou PID, dépassement de la vitesse, by-pass, délestage Hiver (voir le manuel pour plus de détails).

Le contrôleur **CBG** est le dispositif le plus simple, pour la régulation de pression de fonctionnement des petits condenseurs.

SILENCIEUX - THE WHISPERER® PLUS

Le nouveau silencieux compact étudié et éprouvé dans le laboratoire **LU-VE** permet une réduction significative du niveau de pression sonore, jusqu'à **6,5 dB(A)**.

Equiper les condenseurs et dry coolers du **THE WHISPERER® PLUS** présente les avantages suivants:

- Economie d'énergie jusqu'à 19%
- Réduction du niveau de pression sonore pour une puissance égale
- Augmentation de la puissance pour un niveau de pression sonore identique
- Réduction des dimensions des appareils pour une puissance et un niveau de pression sonore identiques
- Elimination des recirculations d'air chaud.



DRY and SPRAY

Pour condenseurs et dry coolers de fortes puissances.

NO

Health hazards (i.e. LEGIONELLA) related to open warm water reservoirs



LESS

Water consumption!
Energy!
Noise!
Pollution!
Operating cost!

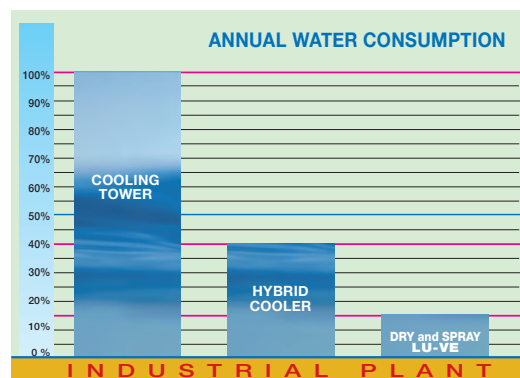
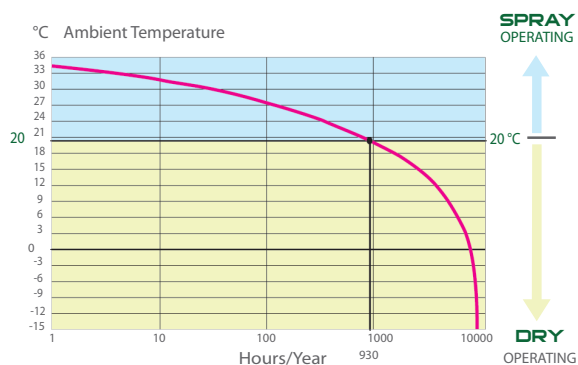

Annual water consumption for a generic industrial installation (on average from 3 to 10 times less than a traditional cooling tower)

Pour condenseurs et dry coolers de fortes puissances. Des recherches poussées ont permis d'améliorer les performances du Spray System, donnant ainsi naissance à la gamme Dry and Spray. La puissance considérable, due à une vaporisation d'eau très efficace, permet d'offrir une alternative valable aux traditionnelles tours de refroidissement avec des avantages intéressants.

FONCTIONNEMENT

Les produits "Dry and Spray" fonctionnent comme les dry coolers traditionnels jusqu'à ce que la température d'air soit suffisamment basse pour maintenir la puissance de refroidissement et la température du liquide à refroidir (ou la pression de condensation) dans les conditions du projet (fonctionnement dry).

La température de passage du fonctionnement DRY au fonctionnement SPRAY se situe généralement autour de 20 °C mais peut être imposée à une autre valeur.

Cette technologie innovante permet d'obtenir, en fonction de la température du bulbe humide de l'air ambiant, une température du liquide de refroidissement égale ou inférieure à la température du bulbe sec de l'air ambiant, avec des économies d'énergie importantes.

Un système de contrôle sophistiqué adapte la vitesse de rotation des ventilateurs et la quantité d'eau vaporisée.

AVANTAGES

L'utilisation des refroidisseurs de liquide et des condenseurs "DRY and SPRAY" en alternative aux tours de refroidissement et condenseurs à air traditionnels offre les avantages suivants:

- La consommation d'eau en fonctionnement SPRAY est limitée à de courtes périodes de l'année. Le reste du temps, durant le fonctionnement DRY, on ne consomme pas d'eau.
- L'absence de bac sous la batterie, et donc d'eau chaude stagnante, exclut la concentration d'impuretés dans l'eau et surtout le risque de contamination de l'environnement (**PAS de Légionelle**).
- Fonctionnement de l'installation sans diffusion de gouttelettes d'eau, ni formation de panaches inesthétiques.
- Faible consommation d'énergie.
- Fonctionnement silencieux.
- Amortissement rapide de l'installation.
- Possibilité d'obtenir des puissances thermiques importantes en free-cooling.

Voir catalogue pour la qualité de l'eau à vaporiser.

WATER SPRAY SYSTEM

Pour condenseurs et dry coolers de fortes puissances.



NO

Health hazards (i.e. LEGIONELLA)
related to open warm
water reservoirs



La meilleure solution pour améliorer les performances et réduire les dimensions des produits.

PRINCIPE GENERALE

Les dry coolers et condenseurs sont généralement sélectionnés pour fonctionner correctement en charge thermique maximale avec la température ambiante maximale.

Ces conditions de fonctionnement sévères ne se vérifient toutefois que sur une courte période de l'année alors que le reste du temps, dans des conditions moins difficiles, l'appareil sera surdimensionné.

C'est pour cela que nous avons étudié un nouveau produit qui peut être sélectionné pour des conditions de fonctionnement moins sévères, mais qui peut augmenter ses performances lorsque les conditions sont plus difficiles.

Le nouvel appareil est obtenu en appliquant aux dry coolers et condenseurs traditionnels un système permettant de vaporiser de l'eau en direction opposée à celle du flux d'air qui traverse la batterie.

Avec ce système, il devient possible de refroidir l'air qui traverse la batterie en obtenant une augmentation de la puissance des dry coolers et des condenseurs.

L'utilisation du spray doit être limitée à environ 200 h/an.

Voir catalogue spécifique pour la qualité de l'eau à vaporiser.



LESS

Water consumption!
Energy!
Noise!
Pollution!
Operating cost!







Wärmeaustauscher für
kommerzielle und industrielle Kälte-,
Klima-
und Industrieranwendungen.

LU-VE S.p.A. ist die Muttergesellschaft der **LU-VE** Group. 1985 erwarb **LU-VE** S.p.A. die Firma Contardo S.p.A. die 1928 gegründet wurde. 1986 wurde mit der Produktion begonnen.

LU-VE ist schnell gewachsen und unterscheidet sich, Dank der qualitativ hochwertigen Produkte, der innovativen Forschung in den Laboren, sowie der ansprechenden Ästhetik (außen schön - innen revolutionär).

LU-VE WAR DIE ERSTE FIRMA, DIE AVANTGARDISTISCHE LÖSUNGEN IN DER KOMMERZIELLEN UND INDUSTRIELLEN KÄLTE ANGEWANDT HAT.

- DIE TECHNOLOGIE DER INNEN GERIPPTE ROHRE
- DIE TECHNOLOGIE DER SPEZIALEN WÄRMEAUSTAUSCHEROBERFLÄCHEN
- DIE ZERTIFIZIERUNGEN DER LEISTUNGEN
- INNOVATIVE MATERIALIEN UND FARBEN
- FORTSCHRITTLICHES DESIGN.

Der internationale Erfolg von **LU-VE** auf dem Markt ist durch die Firmenpolitik, die Forschung und Entwicklung, die den Umweltschutz respektiert und die Einhaltung von strengen, ethischen und kommerziellen Prinzipien zu begründen. 2000 war **LU-VE** die erste Firma die das **Eurovent "Certify All"** Zertifikat für die gesamte Produktpalette (Verdampfer, Verflüssiger und Rückkühler) erhielt.

LU-VE und die Gruppe haben eine neue Technologie für die Produkte der Kühlung, Klimatisierung und industriellen Anwendungen, die dann ein konstanter Bestandteil für die ganze Branche geworden ist, konzipiert und realisiert.



LUFTGEKÜHLTE VERFLÜSSIGER

Die Rückkühler werden für industrielle Prozesse für Wasser- oder Flüssigkeitskühlung, sowie für die Kühlung und Klimatisierung eingesetzt (Rückkühlung und freie Kühlung). Durch die von LU-VE entwickelten, patentierten und getesteten Erneuerungen haben die Rückkühler folgende Vorteile:

- niedrige Wartungskosten
- effiziente Funktion bei allen Umgebungsbedingungen
- kein Risiko von Belagbildung und bakterieller Verschmutzung des Kühlmittels.

WÄRMEAUSTAUSCHER

Die außergewöhnliche hohe Leistung der LU-VE Wärmeaustauscher ist auf eine optimale Kombination von speziellen Aluminiumlamellen und Kupferrohren zurückzuführen.

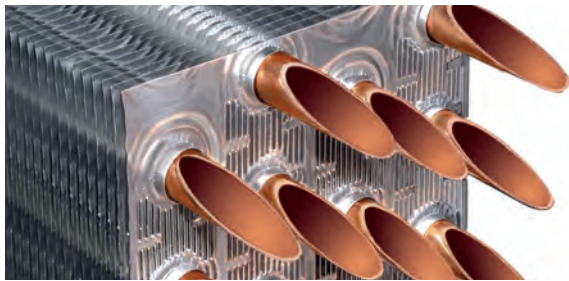

Die Vorteile sind:

- Hohe Leistung mit weniger Luftumwälzung.
- Niedrigerer Stromverbrauch der Motoren.
- Niedriger Schallpegel.

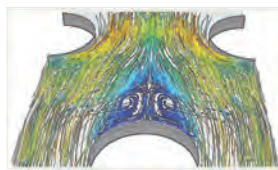

WÄRMEAUSTAUSCHERSCHUTZ

SAFETUBES SYSTEM

Der Schutz der Wärmeaustauscher (SAFETUBES SYSTEM, LU-VE Patent) stellt einen kompletten Schutz der Rohre während der Lieferung, der Installation und der Funktion der Rückkühler sicher.

SAFETUBES SYSTEM®
by LU-VE

EC-VENTILATOREN

Die EC-Ventilatoren (3 ~ 400 V 50 Hz) haben folgende Eigenschaften:

- Hohe Effizienz und niedriger Verbrauch.
- Dauerschmierung und eingebauter thermischer Schutz.
- Statisch und dynamisch ausgewuchtete Motoren und Flügel.



VENTILATORDÜSE

Die hocheffiziente Form der Düse verhindert die Rezirkulation der Luft und reduziert den Schalldruck. Jede Ventilatorlamelle ist von der anderen getrennt (Nur für SAL-XAL-EHL-EAL).

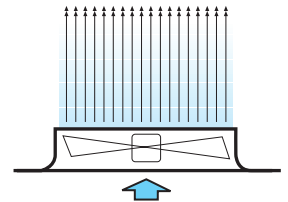

Die Schutzgitter sind, um einen hohen Schutz zu garantieren, gemäß den Vorschriften ausgeführt.

STRUKTUR

SMART (Nur für EHLD-XXLD)

Die patentierte Konstruktion, die auf einem Vibrationstisch getestet wurde, hat folgende große Vorteile:

- Größere Steifigkeit des Produkts
- Minderung des Gesamtgewichtes
- Bessere und gleichmäßigere Luftzirkulation.
- Minimale Leistungsminderung beim Ausfall eines Ventilators.

DESIGN UND MATERIALIEN

Der Grundrahmen besteht aus gezyktem Stahl mit Epoxy-Polyester Pulverbeschichtung, diese ist korrosionsbeständig. Die Kollektoren, die Rohrbogen und die Klemmkästen sind geschützt.

KREISLÄUFE UND ANSCHLÜSSE

Alle Typen können mit verschiedenen Kreisläufen ausgestattet werden, diese werden anhand des Kühlmittels und des Druckverlustes ermittelt.

ENDKONTROLLE

Die Wärmeaustauscher werden, nachdem diese mit trockener Luft entfettet und getrocknet worden sind, mit einem entsprechenden Druck geprüft. Alle Rückkühler werden mit einem Prüfdruck von 12 bar getestet.

WARTUNG

Die Ventilatordüsen und die Seitenteile können einfach demontiert werden, so dass die Motoren, Wärmetauscher und Schaltschränke gewartet werden können.

OPTIONEN

- EC-Motoren
 - Verdrahtung der Motoren auf Klemmkästen
 - ALUPAINT beschichtete Aluminiumlamellen. (*)
 - Kupferlamellen. (*)
 - Flansche.
 - Wärmeaustauscherschutz.
 - Sonderausführungen.
 - Ventilator Drehzahl (siehe Seite 29).
 - Reparaturschalter (IS).
 - Whisperer® Schalldämpfer (siehe Seite 29).
 - Dry and Spray (siehe Seite 30).
 - Water Spray System (siehe Seite 31).
- (*) (siehe Refrigerer® Programm für die Leistungsberechnung).

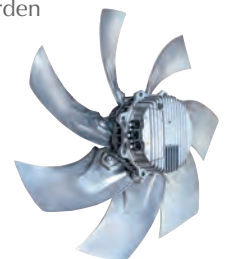

NORMEN

Die Geräte wurden entwickelt und produziert um diese in Maschinen einzubauen die der "Richtlinie 2006/42/EG" entsprechen.



- Richtlinie 2014/29/EG über Elektromagnetische Verträglichkeit.
- Sicherheitsziele der Niederspannungsrichtlinie 2014/35/EG.
- Richtlinie 2014/68/EG für Druckgeräte.

EUROVENT ZERTIFIZIERT

Alle Baureihen der Rückkühler sind EUROVENT zertifiziert.

- (ENV 1048) Leistung.
- Luftvolumenstrom.
- Leistungsaufnahme der Motoren.
- Äußere Wärmeaustauscherfläche.
- Schalldruck- und Schallleistungspegel (EN 13487).
- Druckverlust.
- Energetische Klassifizierung.



STANDARDLEISTUNGSSPEZIFIKATION GEMÄSS ENV 1048

Die Leistungen der Rückkühler sind bei folgenden Bedingungen geprüft:

Außentemperatur (TA)	25°C
Flüssigkeitseintrittstemperatur (TWE)	40°C
Flüssigkeitsaustrittstemperatur (TWU)	35°C
Kühlflüssigkeit	Wasser

ENERGETISCHE KLASSE

Klasse	Energieverbrauch	R
A+	Extrem niedrig	$R \geq 226$
A	Sehr niedrig	$169 \leq R < 226$
B	Niedrig	$109 \leq R < 169$
C	Mittel	$69 \leq R < 109$
D	Hoch	$37 \leq R < 69$
E	Sehr hoch	$R < 37$

R = Leistung (ΔT 15K) / Motorleistungsaufnahme.

ACHTUNG

- Bei Betrieb mit Wasser ohne Glykol, muss gewährleistet sein, dass die Außentemperatur stets über 0 °C ist.
- Um Frostschäden während des Stillstandes der Maschine zu vermeiden, muss der Rückkühler mehrmals mit Druckluft entleert und dann mit Glykol gefüllt werden.
- Eintrittstemperatur ≤60 °C. (Spezielle Ausführung für Temperaturen >60 °C).

ENERGIESYSTEMSTEUERUNG

Die LU-VE Energiesystemsteuerung entspricht der UNI CEI EN 50001:2011 Norm.



QUALITÄTSSTANDARD

Der LU-VE Qualitätsstandard, inklusive Planung, Labor, Erzeugung und Qualitätprüfung ist nach UNI EN ISO 9001:2008 zertifiziert.



2 JAHRE GARANTIE

Alle unsere Produkte bestehen aus Qualitätsprodukten, die strengen Prüfungen unterworfen sind. Die Gewährleistung für diese Produkte beträgt, gleichgültig für welchen Mangel, zwei Jahre.



Von der Gewährleistung ausgeschlossen sind Korrosionsmängel. Bei festgestellten Mängel müssen die Geräte an unser Werk geliefert werden, diese werden überprüft, danach wird beurteilt/entschieden, ob diese Mängel repariert oder das Gerät ersetzt werden muss. Es wird keine Gewährleistung bei Undichtigkeiten oder Gebrauchsschäden übernommen.

Jede Art von Gewährleistung verfällt, sobald festgestellt wird, dass die Geräte nicht ordnungsgemäß benutzt oder falsch installiert wurden. Wir behalten uns vor, jegliche Änderungen die zur Verbesserung der Produktion dienen ohne vorheriger Absprache vorzunehmen.



LU-VE TECHNOLOGY

	<p><i>Steel Protected Best Technology</i></p>	<p>Gehäuse aus verzintem Stahlblech, Epoxy-Polyester korrosionsresistente Beschichtung.</p>
	<p>SAFETUBES SYSTEM® by LU-VE</p>	<p>Das patentierte LU-VE Wärmeaustauscher System SAFETUBES SYSTEM® vermeidet den Kontakt zwischen den Rohren und dem Verflüssigergehäuse und gewährleistet einen kompletten Schutz während dem Transport, der Inbetriebnahme und dem Betrieb.</p>
		<p>Die patentierte und auf einem Vibrationstisch weiterentwickelte und getestete SMART® Konstruktion bietet große Vorteile, bessere Steifigkeit, geringes Gewicht des Produktes, bessere und gleichmäßigere Luftzirkulationen, eine minimale Leistungsminderung im Falle eines Ventilatorausfalles.</p>
		<p>Die Verflüssiger und Rückkühler können mit den neuen elektronischen Ventilatoren mit EC Technologie ausgestattet werden. Dies führt zu drastischen Energieersparnissen.</p>
		<p>Verflüssiger und Rückkühler mit niedrigerem Schall und Energieersparnis.</p>
		<p>Dry and Spray ist die fortschrittlichste Lösung, um die Leistung zu erhöhen und die Abmessungen der Verflüssiger und Rückkühler zu verringern.</p>
		<p>Water Spray System ist eine Lösung, um die Leistung zu maximieren und die Abmessungen der Verflüssiger und Rückkühler bei hoher Leistung zu minimieren.</p>

DREHZAHLEGLER

ZIEL

Der Verflüssigungsdruck der Verflüssiger und die Kühlwassertemperatur der Rückkühler wird innerhalb der angesetzten Werte konstant gehalten, um die Funktionsfähigkeit zu variieren, indem der Energieverbrauch und der Schalldruckpegel der Ventilatoren verringert wird.

SP-SCU*

Drehzahlregler, die nach dem Prinzip des Phasenschnitts arbeiten. Diese können am Hauptschalter **SF** angeschlossen werden und erlauben es Geräte bei niedriger Leistung einfach zu regulieren.

AURT*

Drehzahlregler, die nach dem Prinzip des Phasenschnitts arbeiten. Diese können an den **AQE** Schaltschränken angeschlossen werden und erlauben es Geräte mit niedriger und hoher Leistung genau und wirksam zu regulieren.

ARUS*

Drehzahlregler die auf der fortschrittlichen Technologie der Spannungsregelung basieren. Diese erlauben eine Regulierung frei von elektromagnetischen Geräuschen.

AQE* Schaltschrank - **SPR*** Drucksensor - **STE*** Temperaturfühler - **SF*** Hauptschalter - **IS*** Reparaturschalter.

*Siehe Bedienungsanleitung (www.luve.it).

AUSWAHL

Siehe **REFRIGER®**.



VENTILATOREN MIT "EC" MOTOREN (electronische Kommutation)

Die luftgekühlten Verflüssiger und Trockenkühler können mit den neuen elektronischen Ventilatoren mit EC Technologie ausgerüstet werden. Diese **reduzieren den Energieverbrauch dramatisch**. Die Ventilatoren sind auch mit einem Regelsystem ausgerüstet welche die Drehzahl nach den Anforderungen modulieren kann, mit **exzellentem akustischem Verhalten**. Die Ventilatoren können mit einem 0-10 Vdc Signal oder mit BUS (RS 485) angesteuert werden. Die Ventilatoren sind eigensicher. Diese Ventilatoren können auch mit **ESB** Schaltschränken kombiniert werden. Sie erhalten ein externes 0-10 Vdc Signal und leiten dies zu den Ventilatoren weiter. Alternativ können **ESR** Schaltschränke verwendet werden. Diese, mit einem ECP Regler ausgerüstet, regulieren den Verflüssigungsdruck mit einem Drucksensor (SPR), oder die Flüssigkeitstemperatur mit einem Temperatursensor (STE).

Die Funktion des ECP Reglers beinhaltet:

- Proportional oder PID (proportional-integral-derivative) Regler
- Master/Slave Funktion (Kaskade)
- Management für zwei Eingangs Signale
- Nacht Begrenzung (reduziert den Schall)
- Schnelle Modifikation und Einstellung des Sollwertes
- Fernbedienung von start/stop
- Anschluss über MODBUS Potokoll (auf Anfrage).

Die **ESJ** Schaltschränke sind eine weitere Entwicklung. diese regeln mit dem 0-10 Vdc Signal in der gleichen Weise wie die ESB Modelle und sind ausgerüstet mit magnetisch-thermischen Schutzschaltern pro Ventilator.

Die Thermokontaktverdrahtung ist für jeden individuellen Alarmkontakt der Ventilatoren ausgeführt.

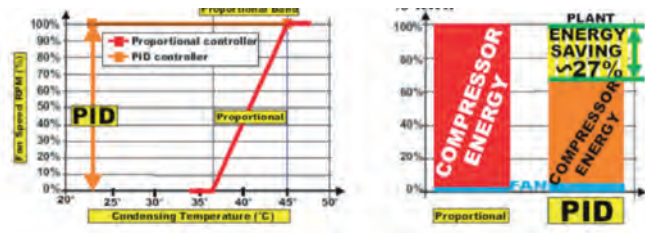

Durch das Verwenden von **ESMC** Schaltschränken ist eine **präzisere Regelung** lieferbar, basierend auf der **ESJ** Technologie und ausgerüstet mit dem höchst fortschrittlichen **WMC2** Regler mit zusätzlichen hilfreichen Funktionen um die Effizienz des System zu maximieren:

- Die Ventilatoren werden über das MODBUS-Protokoll geregelt welche das **komplette Management der Maschinen Daten** inklusive Funktionsdaten für jeden Ventilator, wie Status, Energie Verbrauch, Betriebstemperatur, Alarmer, Betriebsstunden und maximale Drehzahl anzeigt.
 - Der **WMC2** Regler ermöglicht das Aktivieren von vielen wichtigen Funktionen für eine **extrem präzise Regelung der Verflüssiger und Trockenkühler**: P oder PID Regelung, Überdrehzahl, Bypass, Winter EIN/AUS.
- Das einfachste Regel System für Verflüssiger ist der **CBG** Regler, für die Regelung des Betriebs Druckes kleiner Verflüssiger.

SCHALLDÄMPFER - THE WHISPERER® PLUS

Dieser neue kompakte Schalldämpfer, der im **LU-VE** Labor entwickelt und getestet wurde, erlaubt eine drastische Reduzierung des Schalldruckpegels bis zu **6,5 dB(A)**. Die Vorteile, die die Verflüssiger und Rückkühler mit "**THE WHISPERER® PLUS**" erzielen sind folgende:

- Bis zu 19% Energieersparnis
- Reduzierung des Schalldruckpegels bei gleicher Leistung
- Leistungserhöhung bei gleichem Schalldruckpegel
- Weniger Platzbedarf bei gleicher Leistung und gleichem Schalldruckpegel
- Reduzierung der Warmluftrezirkulation.



DRY and SPRAY

Für Verflüssiger und Rückkühler mit hoher Leistung.

NO

Health hazards (i.e. LEGIONELLA)
related to open warm
water reservoirs



LESS

Water consumption!
Energy!
Noise!
Pollution!
Operating cost!

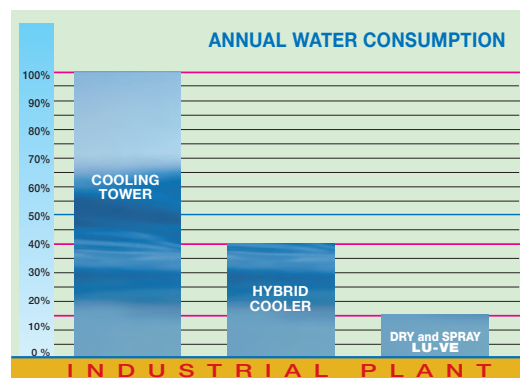
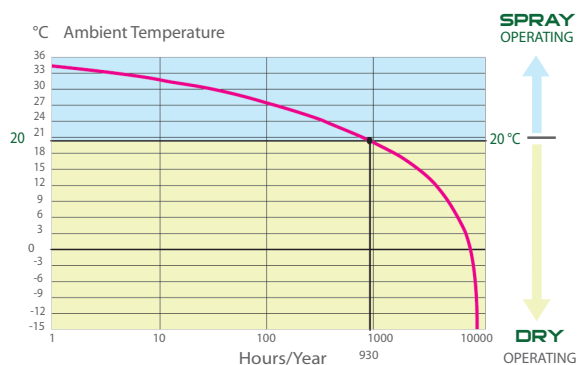

Annual water consumption for a generic industrial installation (on average from 3 to 10 times less than a traditional cooling tower)

Nach einer intensiven zusätzlichen Entwicklung des Spray Systems wurde die neue "Dry and Spray" Baureihe präsentiert.

Die außerordentliche hohe Leistung wird durch eine besondere Effizienz des Sprühwassers erzielt, dieses stellt einen wichtigen Vorteil gegenüber den traditionellen Wärmeaustauschern dar.

BEDIENUNG

Die "Dry and Spray" Baureihe funktioniert wie die traditionelle "DRY" Baureihe, solange die Lufttemperatur so niedrig ist, dass die Kühlleistung und die Temperatur des Kühlmittels (oder den Verflüssigern) erreicht wird. Die Umschalttemperatur von DRY zu SPRAY liegt normalerweise um 20°C.

Diese innovative Technologie ermöglicht den Betrieb bei entsprechender Feuchtkugeltemperatur bei denen die Temperatur des Kühlmittels gleich oder niedriger als die Trockentemperatur ist und dies mit energetischen Vorteilen.

Ein hochentwickeltes Regelsystem ändert die Drehzahl der Ventilatoren und die Menge des benötigten Sprühwassers.

VORTEILE

Die Anwendung der Rückkühler und Verflüssiger "DRY and SPRAY" alternativ zu den traditionellen Kühltürmen sind durch folgende Vorteile charakterisiert:

- Der Wasserverbrauch im SPRAY Betrieb ist auf kurze Zeiten im Jahr beschränkt. Für die langen Zeiten im Jahr mit DRY Betrieb wird kein Wasser verbraucht.
- Keine Tauwasserwanne mit warmen Wasser unter dem Wärmeaustauscher dadurch kein verunreinigtes Wasser, das die Umwelt schädigt (**Keine Legionellen**).
- Die Funktion der Komponenten verhindert Wassertröpfchenauswurf und es gibt keine unästhetische Phasenbildung.
- Niedriger Energieverbrauch.
- Niedriger Schall.
- Kurze Amortisationszeiten.
- Höhere Leistungen mit freier Kühlung.

Siehe spezifischer Katalog für die Sprühwasserqualität.

WATER SPRAY SYSTEM

Für Verflüssiger und Rückkühler mit hoher Leistung.



NO

Health hazards (i.e. LEGIONELLA)
related to open warm
water reservoirs



Die beste Lösung die Leistung zu maximieren und die Größe der Produkte zu minimieren.

GENERELLES PRINZIP

Die Rückkühler und Verflüssiger werden normalerweise ausgewählt um die maximale thermische Leistung mit der maximalen Umgebungstemperatur zu erzielen.

Diese erschwerten Funktionsbedingungen können nur für eine bestimmte Zeit im Jahr auftreten, während der übrigen (Zeit) gibt es weniger beschwerliche Funktionsbedingungen, das Produkt ist überdimensioniert. Deswegen haben wir ein neues Produkt entwickelt das für weniger erschwerte Funktionsbedingungen gewählt werden kann, die Leistung erhöht sich bei zeitweiligen erschwerten Bedingungen.

Das neue Produkt mit Sprühsystem, das seitlich an den Rückkühlern und Verflüssigern montiert ist, versprüht feinerstäubtes Wasser in der entgegengesetzten Richtung des Volumenstroms von den Wärmeaustauscher weg.

Mit diesem System ist es möglich die Luft die in den Wärmetauscher zirkuliert zu kühlen um eine Leistungssteigerung der Rückkühler und Verflüssigern zu erzielen.

Das Sprühsystem darf maximal 200 Stunden im Jahr in Betrieb sein.

Siehe spezifischer Katalog für die Qualität des Sprühwassers.



LESS

Water consumption!
Energy!
Noise!
Pollution!
Operating cost!







Intercambiadores de calor para refrigeración comercial y industrial, acondicionamiento de aire y aplicaciones industriales.

LU-VE S.p.A. es la empresa matriz del Grupo **LU-VE**. En 1985, **LU-VE** S.p.A. adquiere Contardo S.p.A., fundada en 1928. En 1986 inicia su actividad productiva.

LU-VE destaca rápidamente imponiéndose en el mercado gracias a los altos niveles de calidad de sus productos, a las nuevas soluciones creadas en sus laboratorios y al cuidado de la estética (Productos bonitos por fuera - Revolucionarios por dentro).

ES LA PRIMERA COMPAÑÍA DEL MUNDO EN APLICAR SOLUCIONES DE VANGUARDIA EN EL CAMPO DE LA REFRIGERACIÓN COMERCIAL E INDUSTRIAL:

- TECNOLOGÍA DE TUBOS ESTRIADOS
- TECNOLOGÍA A BASE DE SUPERFICIES DE INTERCAMBIO ESPECIALES
- CARACTERÍSTICAS DE FUNCIONAMIENTO CERTIFICADAS
- MATERIALES Y COLORES INNOVADORES
- DISEÑO AVANZADO.

El éxito de **LU-VE** en el mercado internacional se debe a su política de investigación y desarrollo, así como sus principios fundamentales de protección del medio ambiente y al cumplimiento de rigurosas normas éticas y comerciales.

En el 2000, **LU-VE** fue la primera compañía de Europa en conseguir la prestigiosa certificación **Eurovent «Certify All»** para toda la gama de sus productos: evaporadores, condensadores y aero-refrigeradores.

LU-VE y el Grupo han introducido un nuevo concepto en el diseño y fabricación, con distintas tecnologías de los productos destinados a la refrigeración, el acondicionamiento de aire y las aplicaciones industriales, convirtiéndose en una referencia constante para todo el sector.



LOS ENFRIADORES DE LÍQUIDO

Los enfriadores de líquido se utilizan en los procesos industriales (enfriamiento de agua o de otros fluidos), en el acondicionamiento de aire así como en la refrigeración (enfriamiento del agua y free cooling).

Gracias a las innovaciones desarrolladas, patentadas y probadas por LU-VE, los enfriadores de líquido fabricados por nuestra empresa presentan:

- bajos costes de mantenimiento.
- funcionamiento eficaz en todas las condiciones ambientales.
- no presentan riesgos de incrustaciones así como contaminaciones bacteriológicas del líquido que se debe enfriar.

INTERCAMBIADOR DE CALOR

La extraordinaria eficiencia del intercambiador de calor LU-VE se consigue gracias a una combinación óptima de unas aletas especiales de aluminio con tubos de cobre.

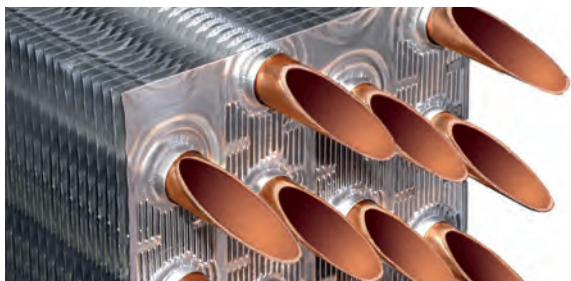

Con las siguientes ventajas:

- potencia elevada con bajo caudal de aire.
- bajo consumo eléctrico de los motores.
- funcionamiento silencioso.

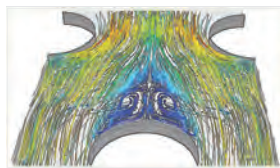

SUSPENSIÓN DE LA BATERÍA

SAFETUBES SYSTEM

El sistema de suspensión de la batería (SAFETUBES SYSTEM®), patentado por LU-VE asegura la completa protección de los tubos durante el transporte, la instalación y el funcionamiento del refrigerador de líquido.

SAFETUBES SYSTEM®
by LU-VE

ELECTROVENTILADORES

Los motores (3 ~ 400 V 50 Hz) se caracterizan por:

- Alta eficiencia y bajo consumo.
- Lubricación permanente y protección térmica incorporada.
- Equilibrados dinámicamente y estáticamente.



BAFLES

Los bafles de soporte de los ventiladores son de alta eficiencia eliminan la recirculación del aire y reducen el nivel de ruido. Cada sección de ventilación está separada de las demás (sólo para SAL-XAL-EHL-EAL). Las rejillas cumplen las más exigentes normas de seguridad para garantizar la máxima protección.

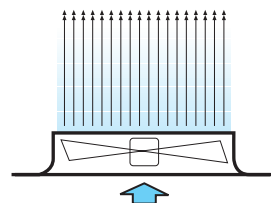

ESTRUCTURA

SMART (sólo para EHL - XXL)

La estructura patentada, ampliamente probada y ensayada en mesas vibrantes, ofrece grandes ventajas:

- Mayor solidez del producto.
- Peso reducido del aparato.
- Mejor circulación del aire y más uniforme.
- Disminución mínima de las prestaciones en caso de parada de un ventilador.

DISEÑO Y MATERIALES

Las carcasas son de acero galvanizado, están pintadas con polvo de Epoxi-Poliéster y son resistentes a la corrosión. Los colectores, los codos y las cajas de derivación se encuentran protegidos.

CIRCUITOS

Todos los modelos se encuentran disponibles con distintos circuitos, que se seleccionan de acuerdo con el caudal del fluido refrigerante y las pérdidas de carga.

ENSAYO

Las baterías se someten a una prueba de presión, después de ser cuidadosamente desengrasadas y secadas con aire seco. Todos los enfriadores de líquido tienen una presión máxima de funcionamiento de 12 bares.

MANTENIMIENTO

Los colectores y los laterales se desmontan fácilmente para una fácil accesibilidad a los motores, a la batería y a las cajas de derivación.

OPCIONES

- Motores "EC".
- Cableado de los motores a la caja de derivación.
- ALUPAINT® de aluminio pintado (PC x 0,97). (*)
- CU de cobre (PC x 1,03). (*)
- Bridas.
- Protección intercambiador de calor.
- Configuraciones especiales.
- Regulación ventiladores (ver pág. 37).
- Interruptor de servicio de ventiladores (IS).
- Whisperer® silenciador (ver pág. 37).
- Dry and Spray (ver pág. 38).
- Water Spray System (ver pág. 39).

(*) (Para la potencia remitirse al programa de cálculo Refriger®).



NORMAS

Todos los productos del catálogo respetan la normativa europea vigente CE.



Los productos han sido diseñados y fabricados para poder formar parte de otra maquinaria de acuerdo con la Directiva de Máquinas 2006/42/CE y sus posteriores modificaciones.

- Directiva 2014/29/CE y posteriores modificaciones, Compatibilidad electromagnética.
- Directiva 2014/35/CE Baja tensión.
- PED 2014/68/CE.

CERTIFICACIONES EUROVENT

Todas las gamas de los enfriadores de líquido han sido certificadas por EUROVENT

- Potencia (ENV 1048).
- Caudales de aire.
- Consumos eléctricos de los motores.
- Superficies externas.
- Niveles de presión y potencia sonora (EN 13487).
- Pérdidas de carga.
- Clase energética.



CARACTERÍSTICAS ESTÁNDAR DE POTENCIA DE ACUERDO CON ENV 1048

La potencia de los enfriadores de líquido se prueba en las condiciones siguientes:

Temperatura ambiente (TA)	25°C
Temperatura de entrada fluido refrigerante (TWE)	40°C
Temperatura de salida fluido refrigerante (TWU)	35°C
Fluido refrigerante	agua

CLASE ENERGÉTICA

Clase	Consumo de energía	R
A+	Extremadamente bajo	$R \geq 226$
A	Muy bajo	$169 \leq R < 226$
B	Bajo	$109 \leq R < 169$
C	Promedio	$69 \leq R < 109$
D	Alto	$37 \leq R < 69$
E	Muy alto	$R < 37$

R = Potencia (ΔT 15K) / consumo de energía motores

ATENCIÓN

- En el caso de utilización de agua sin glicol, es necesario estar seguro de que la temperatura ambiente sea siempre superior a 0° C.
- Para evitar el peligro de congelación durante el periodo de parada, debe vaciarse el enfriador, insuflando aire varias veces.
- Temperatura de entrada del fluido refrigerante ≤ 60 °C. (Versiones especiales para temperaturas > 60 °C).

SISTEMA DE GESTIÓN DE ENERGÍA

El sistema de gestión de energía LU-VE cumple la norma UNI CEI EN 50001:2011 (Italia).



CALIDAD CERTIFICADA

LU-VE ha obtenido el certificado UNI EN ISO 9001:2008, el principal título de homologación existente y que cubre todos los aspectos del desarrollo, realización de pruebas, fabricación y control de calidad.



GARANTÍA DE 2 AÑOS

Todos nuestros productos son fabricados con materiales de calidad y han sido sometidos a exigentes controles. Están garantizados por un periodo de dos años contra cualquier defecto de fabricación.



Se excluyen de la garantía los daños causados por fenómenos de corrosión. Las partes o productos eventualmente defectuosos deben enviarse, a portes pagados, a nuestro fabrica, donde serán verificados para a continuación ser reparados o sustituidos, según nuestro diagnóstico. No asumimos ninguna responsabilidad por pérdidas o daños causados por el uso o por el mal uso de nuestros productos. Toda garantía queda invalidada si se descubre que los productos han sido sometidos a un mal uso o han sido erróneamente instalados. Nos reservamos el derecho de realizar todas las modificaciones oportunas, destinadas a mejorar el rendimiento o el aspecto externo de nuestros productos, sin comunicación previa y sin compromiso respecto a la producción precedente.



LU-VE TECHNOLOGY

	<p><i>Steel Protected Best Technology</i></p>	<p>Carcasa fabricada con acero galvanizado, pintado con polvo de Epoxy-Polyester, resistente a la corrosión.</p>
	<p>SAFETUBES SYSTEM® by LU-VE</p>	<p>El sistema patentado LU-VE de suspensión de la batería SAFETUBES SYSTEM® evita totalmente el contacto de los tubos con la estructura del condensador o del enfriador de líquido, y asegura la completa protección de los tubos durante el transporte, la instalación y el funcionamiento.</p>
		<p>La estructura SMART®, patentada y ampliamente probada, ensayada en mesas vibrantes, proporciona grandes ventajas: mayor solidez del producto, peso reducido del aparato, mejor circulación del aire y más uniforme, disminución mínima de las prestaciones en caso de parada de un ventilador.</p>
		<p>Los condensadores ventilados y los refrigeradores de líquido pueden incorporar nuevos ventiladores electrónicos desarrollados con tecnología EC, que permite reducir drásticamente el consumo energético.</p>
		<p>Condensadores ventilados y enfriadores de líquido para funcionamiento silencioso y bajo consumo energético.</p>
		<p>Dry and Spray es la solución más avanzada para mejorar las prestaciones de los condensadores ventilados y de los enfriadores de líquido de gran potencia para minimizar sus dimensiones.</p>
		<p>Water Spray System es la solución para aumentar las prestaciones de los condensadores ventilados y de los enfriadores de líquido de gran potencia para minimizar sus dimensiones.</p>

REGULADORES ELECTRÓNICOS DE LA VELOCIDAD DE GIRO DE LOS VENTILADORES

PROPÓSITO

Mantener la presión de condensación de los condensadores ventilados y la temperatura del líquido de salida de los enfriadores de líquido dentro de unos valores prefijados, independientemente de las condiciones operativas, reduciendo el consumo de energía y el nivel sonoro de los ventiladores.

SP-SCU*

Reguladores electrónicos basados en el principio del corte de fase. Se pueden asociar al interruptor general SF y permiten regular de un modo simple aparatos de baja y media potencia.

AURT*

Reguladores electrónicos basados en el principio del corte de fase. Se pueden asociar a los cuadros eléctricos serie AQE y permiten regular de un modo preciso y eficaz aparatos de potencia media y alta.

ARUS* Reguladores electrónicos fabricados con la tecnología más avanzada basada en escalones de tensión, que permite una regulación libre de ruidos electromagnéticos.

AQE* Cuadro eléctrico - **SPR*** Sensor de presión - **STE*** Sensor de temperatura - **SF*** Interruptor general - **IS*** Interruptor de servicio.

* Véase el manual de instrucciones (www.luve.it).

SELECCIÓN

Véase **REFRIGER®**.



VENTILADORES CON MOTORES "EC" (conmutación electrónica)

Los enfriadores de aire y los de agua pueden equiparse con los nuevos ventiladores electrónicos desarrollados utilizando tecnología EC, **disminuyendo drásticamente el consumo de energía**. Los ventiladores también están equipados con un sistema de control que puede modular la velocidad de rotación en función de las necesidades, con un **rendimiento acústico excelente**. Los ventiladores pueden ser impulsados por una señal 0-10Vdc o por BUS (RS 485). Los ventiladores están autoprotectidos. Estos ventiladores pueden también combinarse con una serie de paneles eléctricos **ESB** que reciben una señal externa 0-10 Vdc y la transfieren a los ventiladores. Como alternativa, se pueden utilizar paneles eléctricos **ESR**; estos, gracias al controlador ECP, regulan la presión de condensación con la ayuda de un sensor de presión (SPR), o la temperatura del líquido por medio de un sensor de temperatura.

Las funciones del controlador ECO incluyen:

- control proporcional o PID (proporcional-integral-derivado)
 - función maestro/esclavo (cascada)
 - gestión de dos señales de entrada
 - Limitador de noche (reducción de ruido)
 - rápida modificación y establecimiento del punto de ajuste
 - control remoto de inicio/parada
 - connexion a través del protocolo MODBUS (a solicitud).
- Los paneles eléctricos **ESJ** son un desarrollo que va más allá. Ellos gestionan la señal 0-10 Vdc del mismo modo que el modelo ESB y están equipados (además del interruptor principal de línea) con interruptores de

protección magneto- térmicos que impulsan los ventiladores individuales. También hay cableado regleta de terminales para cada contacto de alarma individual de los ventiladores de la unidad.

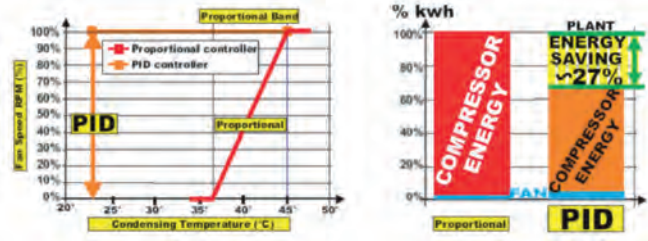

Incluso una regulación más precisa está disponible a través del uso de los paneles eléctricos ESMC, basados en tecnología ESJ y equipados con el más avanzado controlador WMC2 con funciones adicionales para maximizar la eficiencia del sistema:

- Los ventiladores se controlan a través del protocolo MODBUS que hace posible la **gestión completa de los datos de la máquina**, incluyendo los datos de función para cada ventilador, como el estado, el consumo de energía, temperatura de trabajo, las alarmas, las horas de trabajo y la velocidad máxima.
- El controlador **WMC2** permite la activación de muchas importantes funciones especiales para el **manejo extremadamente preciso de condensadores y refrigeradores de líquido**: regulación P o PID, velocidad excesiva, by-pass, invierno ON/OFF. El sistema de control más sencillo para condensadores es el controlador de **CBG**, para la regulación de la presión de trabajo de pequeños condensadores.

SILENCIADOR - THE WHISPERER® PLUS

Este nuevo silenciador compacto diseñado y probado en el laboratorio **LU-VE** asegura una drástica reducción del nivel de presión sonora hasta **6,5 dB(A)**.

Las ventajas que proporciona el uso de condensadores y refrigeradores de líquido fabricados con **THE WHISPERER® PLUS** son las siguientes:

- ahorro energético de hasta un 19%
- reducción del nivel de presión sonora con una misma potencia
- aumento de la potencia para un mismo nivel de presión sonora
- reducción del volumen de los aparatos para un mismo nivel de potencia y de presión sonora
- eliminación de la recirculación de aire caliente.



DRY and SPRAY

Para condensadores y refrigeradores de líquido de gran potencia.

NO

Health hazards (i.e. LEGIONELLA)
related to open warm
water reservoirs



LESS

Water consumption!
Energy!
Noise!
Pollution!
Operating cost!

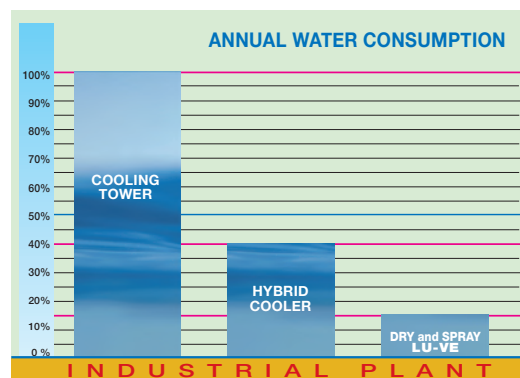
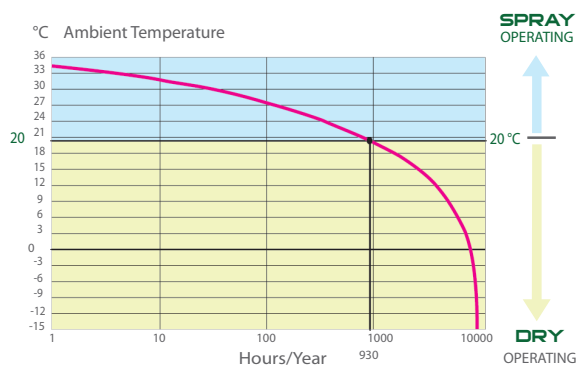

Annual water consumption for a generic industrial installation (on average from 3 to 10 times less than a traditional cooling tower)

Tras una intensa actividad de investigación destinada al aumento de las prestaciones del «spray system» ha nacido la nueva gama «Dry and Spray».

Su extraordinaria potencia, conseguida gracias a una eficiente nebulización del agua, permite crear un producto que constituye una alternativa válida a las tradicionales torres de evaporación con importantes ventajas.

FUNCIONAMIENTO

Los productos «DRY and SPRAY» funcionan como las tradicionales unidades DRY hasta que la temperatura del aire es lo suficientemente baja para mantener la potencia de refrigeración y la temperatura del líquido a refrigerar (o la presión de condensación) se encuentra dentro de las características de diseño (funcionamiento DRY).

La temperatura de paso del funcionamiento DRY al funcionamiento SPRAY es una elección de diseño y se sitúa generalmente entorno a los 20°C.

Esta tecnología innovadora permite conseguir, en función de la temperatura de bulbo húmedo del aire ambiente, una temperatura del líquido refrigerado igual o inferior a la temperatura de bulbo seco del aire ambiente, con importantes ventajas desde el punto de vista energético. Un sofisticado sistema de control varía la velocidad de giro de los ventiladores y la cantidad de agua nebulizada, según sea necesario.

VENTAJAS

El uso de refrigeradores de líquido y de condensadores «DRY and SPRAY» como alternativa a las tradicionales «torres evaporativas» y a los «condensadores evaporativos» presenta las importantes ventajas que se enumeran a continuación:

- Solo durante cortos periodos de tiempo al año se consume agua en el funcionamiento SPRAY. Durante largos periodos al año, en funcionamiento DRY, no se consume agua.
- La ausencia de bandeja bajo la batería con agua caliente estancada excluye la posibilidad de concentración de impurezas en el agua y, sobre todo, el riesgo de contaminación ambiental (**SIN Legionela**).
- Funcionamiento de la instalación sin dispersión de gotas de agua en el ambiente y sin formación de antiestéticas emisiones en forma de pluma.
- Bajo consumo de energía.
- Funcionamiento silencioso.
- Breve periodo de amortización de la instalación.
- Posibilidad de alcanzar alta potencia térmica en free cooling.

Véase el catálogo específico para la calidad del agua destinada a la nebulización.

WATER SPRAY SYSTEM

Para condensadores y refrigeradores de líquido de gran potencia.



NO

Health hazards (i.e. LEGIONELLA)
related to open warm
water reservoirs



La mejor solución para aumentar las prestaciones del producto y disminuir sus dimensiones.

PRINCIPIO GENERAL

Los enfriadores y los condensadores se seleccionan generalmente para funcionar correctamente con la máxima carga térmica y a la máxima temperatura ambiente.

No obstante, estas severas condiciones de funcionamiento se producen solo durante un breve periodo al año, mientras que para el resto del tiempo las condiciones de funcionamiento son menos exigentes y consecuentemente, el producto resulta sobredimensionado.

Por esta razón, hemos diseñado un nuevo producto que puede funcionar en condiciones menos severas pero que puede aumentar las prestaciones cuando se alcancen condiciones de funcionamiento particularmente exigentes.

Este nuevo producto incorpora a los enfriadores y a los condensadores tradicionales un sistema para rociar agua finamente nebulizada en dirección opuesta a la del flujo de aire que atraviesa la batería.

Con este sistema es posible enfriar el aire que atraviesa la batería consiguiendo un aumento de la potencia de los enfriadores y de los condensadores.

El uso del espray debe limitarse a unas 200 horas/año.

Véase el catálogo específico para la calidad del agua destinada a la nebulización.



LESS

Water consumption!
Energy!
Noise!
Pollution!
Operating cost!







Теплообменники
для коммерческого и промышленного
охлаждения,
кондиционирования воздуха
и промышленного применения.

ЛЮ-ВЭ С.П.А., является холдинговой компанией ЛЮ-ВЭ Групп. В 1985 году ЛЮ-ВЭ С.П.А., присоединила Контардо С.П.А., которая была основана в 1928 году. Производство началось в 1986 году.

ЛЮ-ВЭ быстро определила свое место на рынке, благодаря своим высоким стандартам качества, новым техническим решениям, разработанным в своих собственных лабораториях, и благодаря повышенной заботе в изготовлении своей продукции. (Привлекательный внешне –Инновационный внутри).

ЛЮ-ВЭ С.П.А. Это была первая в мире компания по применению передовых технологических решений в области коммерческого и промышленного охлаждения.

- ТЕХНОЛОГИЯ ТРУБ С ВНУТРЕННЕЙ НАСЕЧКОЙ
- ТЕХНОЛОГИЯ СПЕЦИАЛИЗИРОВАННОЙ ПОВЕРХНОСТИ ТЕПЛООБМЕНА
- МНОГОУРОВНЕВАЯ СИСТЕМА СЕРТИФИКАЦИИ
- НОВЫЕ МАТЕРИАЛЫ И ЦВЕТА
- ПРОДВИНУТЫЙ ДИЗАЙН.

В 2000-м году, ЛЮ-ВЭ была первой компанией в Европе, получившей престижный сертификат Eurovent “Certify-All” для всего ряда продукции: воздухоохладители, конденсаторы, охладители жидкости.

Группа ЛЮ-ВЭ представила новые пути создания и разработки холодильной продукции, воздушного кондиционирования и промышленного применения, создавая новые технологии, которые в дальнейшем станут ориентиром для всей индустрии.



Охладители жидкости используются в промышленных процессах (для охлаждения воды или других жидкостей), а так же для воздушного охлаждения.

Благодаря разработанным инновациям, протестированы и запатентованы компанией LU-VE охладители жидкости, являются:

- экономными.
- эффективно работают во всех условиях окружающей среды.
- не представляют риска масштабирования и бактериологического загрязнения жидкости для охлаждения.

ТЕПЛООБМЕННИК

Чрезвычайная эффективность теплообменника LU-VE, связана с оптимальным сочетанием специальных алюминиевых пластин с медными трубами.

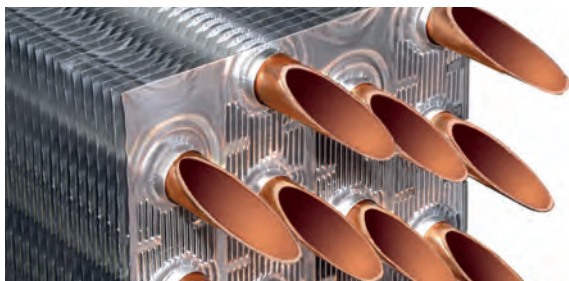

Преимущества:

- Высокая производительность с малым количеством воздуха.
- Тихая работа.

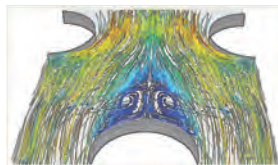

ЗАКРЕПЛЕНИЯ ТЕПЛООБМЕННОЙ БАТАРЕИ

SAFETUBES SYSTEM®

Система закрепления теплообменной батареи (SAFETUBES SYSTEM®, запатентовано LU-VE) гарантирует полную защиту труб во время транспортировки, установки и работы охладителя жидкости.



МОТОРЫ ВЕНТИЛЯТОРА

Моторы (3 ~ 400 V 50 Hz) характеристики:

- Высокая эффективность и низкое потребление.
- Срок службы смазки со встроенной тепловой защитой.
- Динамическая и статистическая балансировка моторов и вентиляторов.



КОЖУХ ВЕНТИЛЯТОРА

Высокоэффективные конструкции кожуха вентилятора исключают рециркуляции воздуха, и снижает уровень шума. Каждая секция вентилятора отделена от другой секции (Только для SAL-XAL-EHL-EAL).

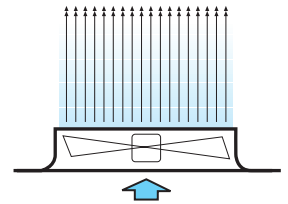

Защитные решетки соответствуют наиболее серьезным правилам техники безопасности, гарантируя максимальную защиту.

СТРУКТУРА

Технология SMART

(технология самоконтроля) (Только для EHL - XXL) Запатентованная структура, тщательно протестирована на вибрирующих опорах, обеспечивает преимущества:

- Большая упругость.
- Уменьшенный вес.
- Лучшее и большее равномерное распределение воздуха.
- Минимальное снижение производительности в случае остановки вентилятора.

ДИЗАЙН И МАТЕРИАЛЫ

Оболочка сделана из коррозионно-стойкой оцинкованной стали с эпоксидно-полиэфирной порошковой краской. Верхний слой, отводы и распределительные коробки все защищены.

СХЕМЫ И СОЕДИНЕНИЯ

Все модели выпускаются с различными схемами, которые будут отображены в соответствии с расходом хладагента жидкости и падением давления.

КОНЕЧНОЕ ТЕСТИРОВАНИЕ

Конечное тестирование проводится при определенном давлении, после того, как катушки тщательно очищены от масел и высушены. Все охладители жидкости имеют максимальное давление 12 бар.

ТЕХНИЧЕСКАЯ ПОДДЕРЖКА

Оболочка вентилятора и боковые панели, могут легко сниматься и обеспечивать полный доступ к мотору, катушке и распределительной коробке.

ОПЦИИ

- ЕС моторы
- Моторы подсоединены к распределительной коробке
- ALUPAINT® из окрашенного алюминия (обратитесь к программе Refriger®, на сайте) (*)
- CU медный (*)
- Фланец.
- Защитные решетки теплообменника.
- Специальные конфигурации.
- Регулятор скорости вентилятора (см. стр. 45).
- Аварийные выключатели (IS).
- Whisperer® Шумоподавитель (см. стр. 45).
- Dry and Spray (см. стр. 46).
- Water Spray System (см. стр. 47).

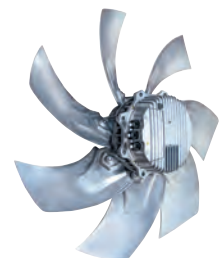

(*) (обратитесь к программе Refriger®, на сайте).

СТАНДАРТЫ

Продукция предназначена для подключения, как определено директивой EC Machine Directive 2006/42/CE и последующими модификациями.



- Директива 2014/29/CE и последующие модификации Электромагнитная совместимость.
- Директива 2014/35/CE Низкое напряжение.
- PED 2014/68/CE

СЕРТИФИКАЦИЯ ЕВРОВЕНТ

Внутренняя серия охладителей жидкости сертифицирована EUROVENT

- Мощность (ENV 1048).
- Количество воздуха.
- Мощность двигателя вентилятора.
- Внешняя поверхность.
- Звуковое давление и уровень мощности (EN 13487).
- Падение давления.
- Классификация энергии.



СТАНДАРТНЫЕ СПЕЦИФИКАЦИИ МОЩНОСТИ ДЛЯ ENV 1048

Мощности охладителей жидкости протестированы в следующих условиях:

Температура окружающей среды	25°C
Температура хладагента на входе жидкости	40°C
Температура хладагента на выходе жидкости	35°C
хладагента жидкости	ВОДЫ

КЛАСС ЭНЕРГОПОТРЕБЛЕНИЯ

Класс	Энергопотребление	R
A+	Совсем низкое	$R \geq 226$
A	Очень низкое	$169 \leq R < 226$
B	Низкое	$109 \leq R < 169$
C	Средний	$69 \leq R < 109$
D	Высокий	$37 \leq R < 69$
E	Очень высокий	$R < 37$

R = Мощность (ΔT 15K) / мощность мотора.

ПРЕДУПРЕЖДЕНИЕ

- Если вода используется без гликоля, то температура окружающей среды должна быть 0 °C.
- Для предотвращения замерзания во время остановки, слейте охладитель жидкости, продувая воздух несколько раз, а затем введите гликоль.
- Температура хладагента на входе жидкости ≤ 60 °C. (Специальная версия для температуры >60 °C).

ЭНЕРГЕТИЧЕСКАЯ СИСТЕМА УПРАВЛЕНИЯ

Система управления энергией LU-VE соответствует UNI CEI EN 50001:2011.



ГАРАНТИЯ КАЧЕСТВА

ЛЮ-ВЭ является компанией сертифицированной UNI EN ISO 9001:2008, что является важной квалификацией Гарантии Качества, Развития, Тестирования, методы и процедуры проверки оборудования.



2 ГОДА ГАРАНТИИ

Всенашеоборудованиепроизведено из высококачественных материалов и проходит строгий выходной контроль.

Повреждения, причиненные коррозионными агентами, исключены.

Компоненты и детали с обнаруженными дефектами должны быть возвращены на наш завод с предоплатой за перевозку груза, где они будут проверены, и в зависимости от экспертизы будут отремонтированы или заменены. Мы не несем ответственность за протечки и повреждения, в результате неправильного использования нашей продукции. Гарантия не распространяется на случаи неправильной инсталляции оборудования. Мы оставляем за собой право вносить изменения в целях повышения производительности и внешнего вида наших изделий в любое время без предварительного уведомления и без каких-либо обязательств перед предыдущим производством.



LU-VE TECHNOLOGY

	<p><i>Steel Protected Best Technology</i></p>	<p>Оцинкованная сталь с антикоррозийным покрытием Exposy-Polester.</p>
	<p>SAFETUBES SYSTEM® by LU-VE</p>	<p>Запатентованная система крепления теплообменных батарей LU-VE SAFETUBES SYSTEM® полностью исключает возможность контакта трубок с корпусом охладителя жидкости и таким образом полностью защищает теплообменную батарею во время транспортировки и монтажа.</p>
		<p>Запатентованная структура SMART протестированная на вибрирующей платформе имеет много преимуществ таких как: более устойчивое к повреждениям, уменьшенный вес, лучшая циркуляция воздуха, минимальная потеря работоспособности в случае остановки одного мотора.</p>
		<p>Конденсаторы и охладители жидкости могут быть оснащены новыми электронными вентиляторами, разработанными с использованием ЕС технологий, значительно уменьшая потребление энергии.</p>
		<p>Конденсаторы и охладители жидкости с низким уровнем шума при работе и низким потреблением энергии.</p>
		<p>Dry and Spray является передовым решением для поддержки работоспособности и минимизации объема конденсаторов и охладителей жидкости.</p>
		<p>Water Spray System решение для увеличения работоспособности и уменьшения объема конденсаторов и охладителей жидкости большой мощности.</p>

ЭЛЕКТРОННЫЕ ДАТЧИКИ УПРАВЛЕНИЯ ВЕНТИЛЯТОРОМ

НАЗНАЧЕНИЯ

Регулятор скорости вращения вентилятора необходим для поддержания давления конденсации (для конденсаторов) и температуры жидкости на выходе (для сухих градирен) в заданном диапазоне, в то же время, уменьшая энергопотребление и уровень шума вентиляторов.

SP-SCU*

Электронные регуляторы скорости вращения вентилятора основаны на принципе отсечения фазы. Они могут быть связаны с главным выключателем SF.

AURT*

Электронные регуляторы скорости вращения вентилятора основаны на принципе отсечения фазы. Они могут быть связаны с электрической панелью AQE, и позволяет управлять средней и высокой мощностью, одновременно эффективно и точно. Эти регуляторы скорости вращения вентиляторов абсолютно просты в использовании.

ARUS*

Электронные регуляторы скорости вращения вентилятора изготовлены с помощью высоких технологий, и основаны на частотном регулировании; эта технология позволяет регулирование без электромагнитного шума.

AQE* Электрическая панель - **SPR*** Датчик давления - **STE*** Датчик температуры - **SF*** Главный выключатель - **IS*** Изолированный выключатель.

*Смотрите каталог Инструкция (www.luve.it).

ВЫБОР

Смотрите REFRIGER®



ВЕНТИЛЯТОРЫ С «ЕС» МОТОРАМИ

(Электронная коммутация)

Воздушные конденсаторы и сухие градирни могут быть оснащены новыми электронными вентиляторами с применением ЕС технологий, **значительно уменьшая энергопотребление**. Вентиляторы так же оснащены системой управления, которая может менять скорость вращения, в зависимости от параметров, с **низким уровнем шума**. Эти вентиляторы могут управляться с помощью сигнала 0-10 В или BUS (RS 485). Есть встроенная защита. Данные вентиляторы могут работать совместно с электрическими панелями **ESB**, которые получают внешний сигнал 0-10В и трансформируют его вентиляторам (требуются датчики). Электрические панели **ESR** могут работать, благодаря регулятору ECP, регулировать давление конденсации с помощью датчика давления (SPR), или температуры рабочей жидкости с помощью датчика температуры (STE).

Регулятор ECP включает:

- пропорциональный или PID регулирование
- Master/Slave функции (cascade)
- управление двумя сигналами на входе
- ночной лимит (уменьшенный шум)
- изменение скоростей вращения вентилятора и установка заданных скоростей
- дистанционное управление start/stop
- подключение с помощью протокола MODBUS (по запросу).

Электрические панели **ESJ**, являются последней разработкой. Они управляют сигналом 0-10 В, таким же способом, как и модель **ESB** и оснащены (в дополнение к главному выключателю) термомангнитными защитными выключателями, которые управляют отдельными вентиляторами. На каждом вентиляторе, установлена контактная колодка для каждого отдельного аварийного контакта.

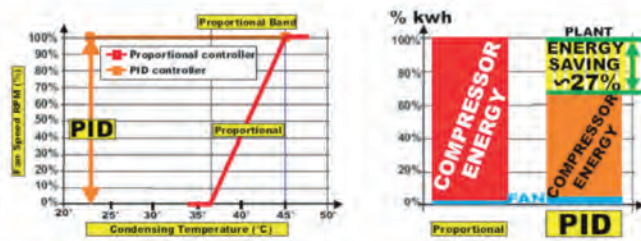

Еще более точное управление доступно, за счет электрических панелей **ESMC**, оснащение высокотехнологичными **WMC2** датчиками, с дополнительной функцией усиления эффективности системы:

- Эти вентиляторы управляются с помощью протокола MODBUS, что позволяет управлять всеми данными машины, в том числе и функциональными данными для каждого вентилятора, например: потребление энергии, рабочую температуру, сигналы аварии, рабочее время и максимальную скорость.

- Регулятор **WMC2** активирует множество специальных функций для **точного управления конденсаторами и сухими градирнями**: управление P или PID, контроль превышения скорости, шунтирование, в зимнее время on/off (см. инструкцию).

Самой простой системой управления конденсаторов является регулятор **CBG**, для регулирования рабочего давления небольших конденсаторов.

ГЛУШИТЕЛЬ - THE WHISPERER® PLUS

Этот компактный глушитель разработан и протестирован в лабораториях **ЛЮ-ВЭ**, снижает уровень звукового давления до **6,5 дБ(А)**. Конденсаторы и охладители жидкости с **THE WHISPERER® PLUS** обеспечивают следующие преимущества:

- Экономия энергии до 19%
- снижение уровня звукового давления при равной мощности
- увеличение мощности на равном уровне звукового давления
- меньше площадь размещения в равной мощности и уровня звукового давления
- устранение теплой рециркуляции воздуха.



DRY and SPRAY

Для конденсаторов с воздушным охлаждением и сухих градирен большой производительности.

NO

Health hazards (i.e. LEGIONELLA)
related to open warm
water reservoirs

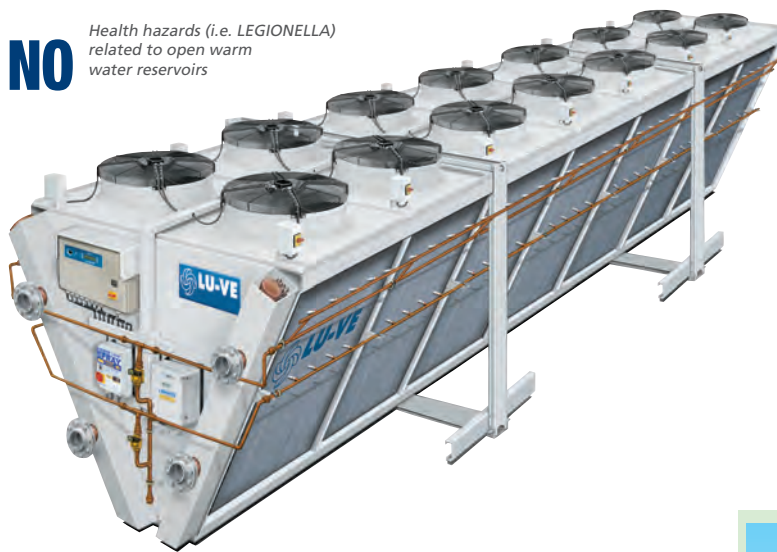

LESS

Water consumption!
Energy!
Noise!
Pollution!
Operating cost!

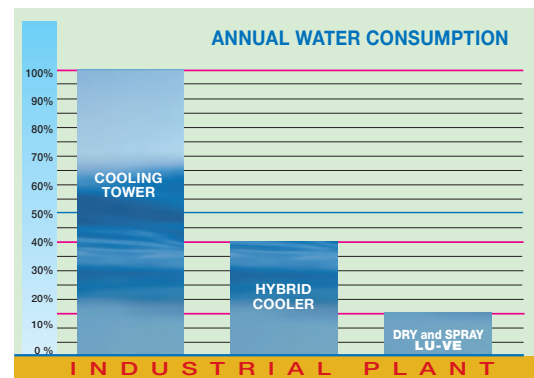
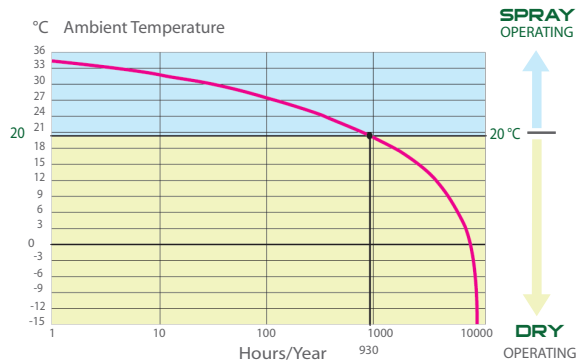

Annual water consumption for a generic industrial installation (on average from 3 to 10 times less than a traditional cooling tower)

Для конденсаторов с воздушным охлаждением и сухих градирен большой производительности.

После важной научно-исследовательской деятельности направленной на повышение потенциала системы распыления, был проведен новый диапазон системы "Dry and Spray". Экстраординарная производительность в связи с высокой эффективностью распыления воды позволяет стать альтернативой традиционным градирням со значительным преимуществом.

РАБОТА

ПРЕИМУЩЕСТВА

Обратитесь к конкретным каталогам качества распыляемой воды.

WATER SPRAY SYSTEM

Для конденсаторов с воздушным охлаждением и сухих градирен большой производительности.



NO

Health hazards (i.e. LEGIONELLA)
related to open warm
water reservoirs



Лучшее решение для повышения производительности и минимизации установочных размеров.

ОСНОВНОЙ ПРИНЦИП

Охладители жидкости и конденсаторы обычно подбираются при максимальной нагрузке и максимальной температуре окружающей среды.

Эти непростые условия могут произойти только в очень короткий период года, в то время как остальное время года, в менее трудных условиях работы, оборудование переразмеренно.

По этой причине мы разработали новое оборудование, которое может быть подобрано для менее трудных условий работы, но в определенных трудных условиях производительность возрастает.

Новый продукт состоит из системы орошения (WSS) установленной на стандартных конденсаторах и градирнях, которые мелко распыляют воду в противоположном направлении от теплообменной батареи таким образом, можно охлаждать воздух, поступающий в теплообменник, тем самым увеличивая мощность охладителей жидкости и конденсаторов.

Использование распылителя должно быть ограниченным примерно 200 часов в год.

Обратитесь к конкретным каталогам качества распыляемой воды.



LESS

Water consumption!
Energy!
Noise!
Pollution!
Operating cost!







**Wymienniki ciepła
dla chłodnictwa komercyjnego i przemysłowego,
dla klimatyzacji
oraz aplikacji przemysłowych.**

LU-VE S.p.A. jest spółką matką Grupy LU-VE. W 1985 roku, LU-VE S.p.A. dokonuje zakupu firmy Contardo S.p.A. powstałej w 1928 roku. W 1986 rozpoczyna swoją działalność produkcyjną.

LU-VE wyróżnia się dzięki swoim wysokim standardom jakości produktów, dzięki nowym rozwiązaniom, opracowanym w swoich laboratoriach i dzięki jakości estetyki (piękni na zewnątrz - rewolucyjni w środku).

TO PIERWSZA FIRMA NA ŚWIECIE, KTÓRA ZASTOSOWAŁA NOWOCZESNE ROZWIĄZANIA I WPROWADZIŁA NOWE STANDARDY W SEKTORZE CHŁODNICTWA KOMERCYJNEGO I PRZEMYSŁOWEGO:

- TECHNOLOGIĘ ROWKOWANYCH RUREK
- TECHNOLOGIĘ WYSPECJALIZOWANYCH POWIERZCHNI WYMIANY
- CERTYFIKATY POTWIERDZAJĄCE CHARAKTERYSTYKI PRACY URZĄDZEŃ
- INNOWACYJNE MATERIAŁY I KOLORY
- NOWOCZESNY DESIGN.

Sukces na rynku międzynarodowym Grupy LU-VE wywodzi się z polityki ciągłych badań i rozwoju, a także z respektowania fundamentalnych zasad ochrony środowiska.

W 2000 roku LU-VE była pierwszą firmą w Europie, która otrzymała prestiżowe certyfikaty Eurovent "Certify All" dla całej gamy swoich produktów: chłodnic powietrza, skraplaczy i suchych chłodnic cieczy.

LU-VE i cała Grupa wprowadziły nowy sposób pojmowania i tworzenia produktów dla sektora chłodnictwa, klimatyzacji i zastosowań przemysłowych, według technologii, która stała się następnie stałym odniesieniem dla całej branży.



SUCHE CHŁODNICE CIECZY

Suche chłodnice cieczy są wykorzystywane w procesach przemysłowych (chłodzenie wody lub innych płynów) oraz w klimatyzacji i chłodnictwie (chłodzenie wody i free cooling).

Dzięki wprowadzonym innowacjom, opatentowanym i testowanym przez LU-VE, suche chłodnice cieczy produkowane przez firmę charakteryzują się:

- Niskimi kosztami operacyjnymi.
- Wysoką efektywnością w każdych warunkach pracy.
- Brakiem ryzyka osadzenia się zanieczyszczeń i skażenia bakteriologicznego chłodzonego medium.

WYMIENNIK CIEPŁA

Niezwykle wysoka wydajność wymiennika ciepła LU-VE została osiągnięta dzięki optymalnej kombinacji nowych, aluminiowych lamel z miedzianymi rurkami.

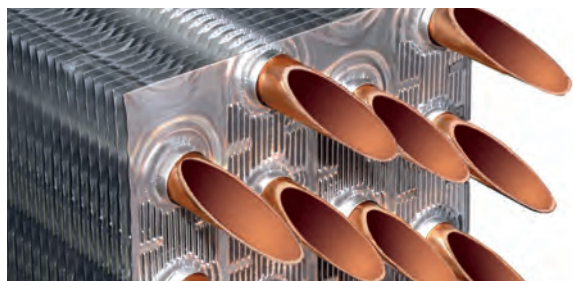

Uzyskano:

- Wyższą wydajność przy małym przepływie powietrza.
- Niskie zużycie energii silników wentylatorów.
- Niski hałas.

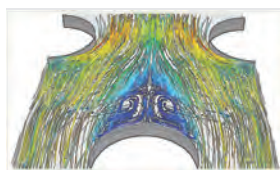

PODPARCIE WYMIENNIKA SAFETUBES SYSTEM

SAFETUBES SYSTEM®
by LU-VE

System podparcia wymiennika SAFETUBES SYSTEM®, opatentowany przez LU-VE, zapewnia całkowitą ochronę rurek wymiennika przed uszkodzeniem podczas transportu, instalacji i pracy chłodnicy.

WENTYLATORY

Silniki (3 ~ 400 V 50 Hz) charakteryzują się:

- Wysoką wydajnością i niskim zużyciem energii.
- Są bezobsługowe, mają wbudowaną ochronę termiczną.
- Silniki i wentylatory są wyważone statycznie i dynamicznie.



DYSZE WENTYLATORÓW

Nowa wysokowydajna dysza wentylatora eliminuje ryzyko recyrkulacji powietrza i zmniejsza hałas. Każdy wentylator znajduje się w osobnej sekcji oddzielonej od innych za pomocą przegród (tylko dla SAL-XAL-EHL-EAL).

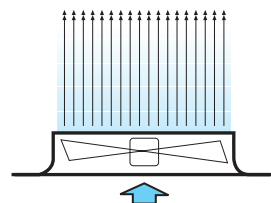

Ośłony wentylatorów odpowiadają najbardziej surowym normom bezpieczeństwa w celu zagwarantowania najwyższej ochrony.

KONSTRUKCJA

SMART (tylko dla EHL - XXL)

Opatentowany kształt ramy, przetestowany na specjalnej testowej platformie wibrującej, pozwolił na uzyskanie wielu zalet:

- Większa sztywność.
- Zmniejszony ciężar urządzenia.
- Lepszy i bardziej wyrównany przepływ powietrza.
- Minimalny spadek wydajności w przypadku awarii wentylatora.

DESIGN I MATERIAŁY

Obudowa dla wysokiej odporności przed korozją, wykonana jest ze stali ocynkowanej, pokrytej proszkowo farbą epoksy-poliesterową. Kolektory, kolanka oraz skrzynka elektryczna są właściwie zabezpieczone przed uszkodzeniem i warunkami atmosferycznymi.

OBIEGI I PRZYŁĄCZA

Wszystkie modele są dostępne z różnymi obiegami zoptymalizowanymi dla przepływu czynnika chłodzonego oraz strat ciśnienia.

TEST SZCZELNOŚCI

Wymienniki, po odtłuszczeniu i osuszeniu suchym powietrzem, poddawane są kontroli szczelności pod odpowiednim ciśnieniem. Maksymalne ciśnienie robocze dla wszystkich chłodnic cieczy wynosi 12 bar.

KONSERWACJA I OBSŁUGA

Dysze wentylatora i panele boczne można w bardzo prosty sposób zdemontować, a dostęp do silników, samego wymiennika oraz skrzynek elektrycznych jest łatwy i bezproblemowy.

OPCJE

- Silniki elektronicznie komutowane (EC).
- Wentylatory okablowane do skrzynki elektrycznej.
- ALUPAINT® antykorozyjna powłoka zabezpieczająca. (*)
- CU: lamele miedziane. (*)
- Kołnierz.
- Zabezpieczenie wymiennika ciepła.
- Wersje specjalne.
- Regulacja prędkości obr. (patrz str. 53).
- Wyłączniki serwisowe wentylatorów (IS).
- Tłumiki Whisperer® (patrz str. 53).
- Dry and Spray (patrz str. 54).
- Water Spray System (patrz str. 55).

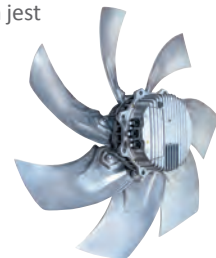

(*) (Dla zakresu wydajności odnieść się do programu doborowego Refriger®).

NORMY

Urządzenia zostały zaprojektowane i skonstruowane tak, aby mogły być zastosowane w maszynach według Dyrektywy Maszynowej 2006/42/CE (wraz z późniejszymi zmianami) oraz odpowiadają następującym normom bezpieczeństwa:



- Dyrektywa 2014/29/CE wraz z późniejszymi zmianami
Kompatybilność elektromagnetyczna.
- Dyrektywa 2014/35/CE dotycząca niskiego ciśnienia.
- PED 2014/68/CE

CERTYFIKAT EUROVENT

Cały typoszereg suchych chłodziń cieczy posiada certyfikat EUROVENT.

- Wydajność (ENV 1048).
- Przepływ powietrza.
- Zużycie energii.
- Powierzchnia zewnętrzna.
- Poziomy ciśnienia i mocy akustycznej (EN 13487).
- Spadki ciśnienia.
- Klasa energetyczna.



STANDARDOWE CHARAKTERYSTYKI WYDAJNOŚCI WG ENV 1048

Wydajności suchych chłodziń cieczy są testowane zgodnie z następującymi warunkami:

Temperatura otoczenia (TA)	25°C
Temperatura czynnika na wejściu (TWE)	40°C
Temperatura czynnika na wyjściu (TWU)	35°C
Czynnik chłodzony	woda

KLASA ENERGETYCZNA

Klasa	Zużycie energii	R
A+	Energooszczędne	$R \geq 226$
A	Bardzo niskie	$169 \leq R < 226$
B	Niskie	$109 \leq R < 169$
C	Średnie	$69 \leq R < 109$
D	Wysokie	$37 \leq R < 69$
E	Bardzo wysokie	$R < 37$

R = Wydajność (ΔT 15K) / zużycie energii silników.

UWAGA

- W przypadku zastosowania wody bez glikolu, należy upewnić się, iż temperatura otoczenia będzie zawsze wyższa od 0 °C.
- Aby uniknąć niebezpieczeństwa zamrożenia chłodziń, podczas przerwy w pracy urządzenia, należy je opróżnić, przedmuchać kilkakrotnie powietrzem i przepłukać glikolem.
- Standardowa temperatura na wejściu czynnika chłodzonego ≤ 60 °C (wersje specjalne dla temperatur > 60 °C).

SYSTEM ZARZĄDZANIA ENERGIĄ

System zarządzania energią LU-VE jest zgodny z normą UNI CEI EN 50001:2011.



GWARANCJA JAKOŚCI

Firma LU-VE posiada certyfikat UNI EN ISO9001:2008, zapewniający najwyższą jakość w aspekcie: projektowania, testów przedprodukcyjnych, systemów produkcji i kontroli jakości produkcji.



DWULETNIĄ GWARANCJĄ

Wszystkie nasze produkty są wykonane z materiałów wysokiej jakości oraz są poddawane rygorystycznym testom. Ponadto, posiadają dwuletnią gwarancję na wszelkiego rodzaju wady konstrukcyjne.



Szkody powstałe na skutek korozji nie podlegają gwarancji. Ewentualne części lub urządzenia wykazane jako uszkodzone muszą zostać zwrócone do naszego Zakładu, za uprzednim opłaceniem kosztu przewozu. Elementy takie zostaną poddane kontroli oraz, w zależności od naszej oceny, naprawione lub wymienione. Za straty lub szkody spowodowane niewłaściwym użytkowaniem lub niepoprawnym zainstalowaniem naszych produktów nasza firma nie ponosi odpowiedzialności.

Gwarancja traci ważność w momencie wykazania niewłaściwego użytkowania naszych produktów lub ich błędnego zainstalowania. Zastrzegamy sobie prawo do zmiany charakterystyki lub ulepszenia produktów bez uprzedniego informowania o tym procesie oraz bez zobowiązań wobec właścicieli zakupionych wcześniej urządzeń.



LU-VE TECHNOLOGY

	<p><i>Steel Protected Best Technology</i></p>	<p>Obudowa dla wysokiej odporności przed korozją, wykonana jest ze stali ocynkowanej, pokrytej proszkowo farbą epoksy-poliesterową.</p>
	<p>SAFETUBES SYSTEM® by LU-VE</p>	<p>Opatentowany system podparcia wymiennika LU-VE SAFETUBES SYSTEM® wyklucza całkowicie kontakt rurek z ramą skraplacza lub suchej chłodnicy cieczy i zapewnia całkowitą ochronę rurek wymiennika przed uszkodzeniem podczas transportu, instalacji i pracy.</p>
		<p>Opatentowany kształt ramy SMART®, przetestowany na specjalnej testowej platformie wibrującej, pozwolił na uzyskanie wielu zalet, takich jak: większa sztywność, zmniejszony ciężar urządzenia, lepszy i bardziej wyrównany przepływ powietrza, minimalny spadek wydajności w przypadku awarii wentylatora.</p>
		<p>Skraplacze z wentylatorami osiowymi oraz suche chłodnice cieczy mogą być wyposażone w najnowocześniejsze wentylatory elektronicznie komutowane EC, które pozwalają na radykalną redukcję zużycia energii i hałasu.</p>
		<p>Skraplacze z wentylatorami osiowymi oraz suche chłodnice cieczy charakteryzują się niskim hałasem oraz obniżonym zużyciem energii.</p>
		<p>Dry and Spray, to najbardziej technologicznie zaawansowane rozwiązanie służące zwiększeniu wydajności i zminimalizowaniu gabarytów skraplaczy oraz suchych chłodnic powietrza o dużych mocach chłodniczych.</p>
		<p>Water Spray System jest rozwiązaniem znacząco zwiększającym wydajność i minimalizującym gabaryty skraplaczy oraz suchych chłodnic powietrza o dużych mocach chłodniczych.</p>

ELEKTRONICZNE REGULATORY PRĘDKOŚCI OBROTOWEJ WENTYLATORÓW

CEL STOSOWANIA

Regulator obrotów wentylatorów ma za zadanie utrzymanie na poziomie nastawy ciśnienia skraplania w skraplaczach oraz temperatury płynu na wyjściu w suchych chłodnicach cieczy, przy zmiennych warunkach operacyjnych, zmniejszając jednocześnie zużycie energii oraz poziom hałasu wentylatorów.

SP-SCU*

Elektroniczne regulatory typu cut phase. Montowane wspólnie z wyłącznikiem głównym SF. Pozwalają na prostą regulację urządzeń o małej i średniej wydajności.

AURT*

Elektroniczne regulatory typu cut phase. Montowane wspólnie ze skrzynkami elektrycznymi z serii AQE. Pozwalają na dokładną i efektywną regulację urządzeń o średniej i dużej wydajności. Mają wbudowane wszystkie niezbędne komponenty i są proste w użyciu.

ARUS*

Regulatory elektroniczne wykorzystujące zaawansowaną technologię, bazującą na stopniowaniu napięcia. Regulacja jest całkowicie wolna od szumów elektromagnetycznych. Jest to najlepsze rozwiązanie, gdy wymagany jest szczególnie niski poziom hałasu.

AQE* Skrzynka elektryczna - SPR* Czujnik ciśnienia - STE* Czujnik temperatury - SF* Wyłącznik główny - IS* Wyłącznik serwisowy.

*Patrz Instrukcja Obsługi (www.luve.it).

DOBORY

Patrz REFRIGER®.



WENTYLATORY Z SILNIKAMI "EC"

(elektronicznie komutowane)

Skraplacze freonowe i suche chłodnice cieczy mogą być wyposażone w nowe wentylatory elektryczne opracowane z wykorzystaniem technologii EC, pozwalające na **bardzo dużą redukcję zużycia energii**. Wentylatory EC mają zintegrowany system sterowania, pozwalający na regulację prędkości obrotowej oraz charakteryzują się **doskonałymi właściwościami akustycznymi**. Mogą być kontrolowane sygnałem 0-10 Vdc lub też przez BUS (RS 485). Wentylatory EC mają wbudowane zabezpieczenia elektryczne. Wentylatory EC mogą współpracować z panelem elektrycznym z typoszeregu ESB, który zabezpiecza elektrycznie wentylatory oraz rozdziela zewnętrzny sygnał sterujący 0-10 Vdc i przekazuje do wszystkich wentylatorów. Alternatywnie, można zastosować skrzynkę ESR. Wbudowany regulator ECP kontroluje ciśnienie skraplania za pomocą czujnika ciśnienia (SPR) lub temperaturę cieczy za pomocą czujnika temperatury (STE).

Funkcje regulatora ECP obejmują:

- regulację proporcjonalną lub PID (proporcjonalno-całkująco-różniczkującą)
- funkcja master/slave (kaskada)
- zarządzanie dwoma sygnałami wejściowymi
- nocne ograniczenie obrotów (redukcja hałasu)
- zdalne przełączanie nastawy
- zdalny sygnał start/stop
- zdalny interfejs w protokole MODBUS (na życzenie).

Panele ESJ stanowią rozwinięcie skrzynki ESB. Zarządzają sygnałem 0-10 Vdc, jak ESB i posiadają również oprócz głównego wyłącznika, zabezpieczenia w postaci indywidualnych wyłączników magneto-termicznych dla każdego wentylatora. Z każdego wentylatora wyprowadzony jest na listwę zaciskową sygnał alarmu.

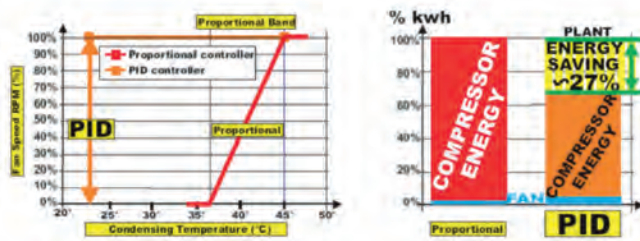

Najbardziej zaawansowaną regulację oferują panele ESMC, bazujące na technologii ESJ i wyposażone w najmocniej rozbudowany sterownik WMC2, posiadający dodatkowe użyteczne funkcje maksymalizujące efektywność i elastyczność pracy urządzenia.

• Wentylatory są kontrolowane poprzez magistralę Modbus, która umożliwia **całościowe zarządzanie parametrami urządzenia**, włącznie z danymi roboczymi każdego wentylatora, takimi jak bieżący status, zużycie energii, temperatura pracy, alarmy, ilość godzin pracy, maksymalna prędkość.

• Sterownik WMC2 pozwala na aktywację wielu ważnych funkcji specjalnych służących do bardzo **precyzyjnego zarządzania skraplaczami i suchymi chłodnicami cieczy**, takich jak m. in.: regulacja P lub PID, overspeed, by-pass, winter ON/OFF. Najprostszy system sterowania to regulator CBG montowany bezpośrednio na kolektorze, pozwalający na regulację ciśnienia małych skraplaczy.

TŁUMIKI HAŁASU - THE WHISPERER® PLUS

Kompaktowy tłumik hałasu zaprojektowany i przetestowany w laboratorium LU-VE zapewnia znaczącą redukcję poziomu ciśnienia akustycznego, nawet do **6,5 dB(A)**.

System tłumików **THE WHISPERER® PLUS** zapewnia następujące korzyści:

- oszczędność energii nawet do 19%
- obniżenie poziomu ciśnienia akustycznego przy tym samym poziomie wydajności
- wzrost wydajności przy tym samym poziomie ciśnienia akustycznego
- zmniejszenie gabarytów urządzeń przy tej samej wydajności i poziomie ciśnienia akustycznego
- eliminacja recyrkulacji gorącego powietrza.



DRY and SPRAY

Dla skraplaczy i suchych chłodziń powietrza o dużych wydajnościach.

NO Health hazards (i.e. LEGIONELLA) related to open warm water reservoirs

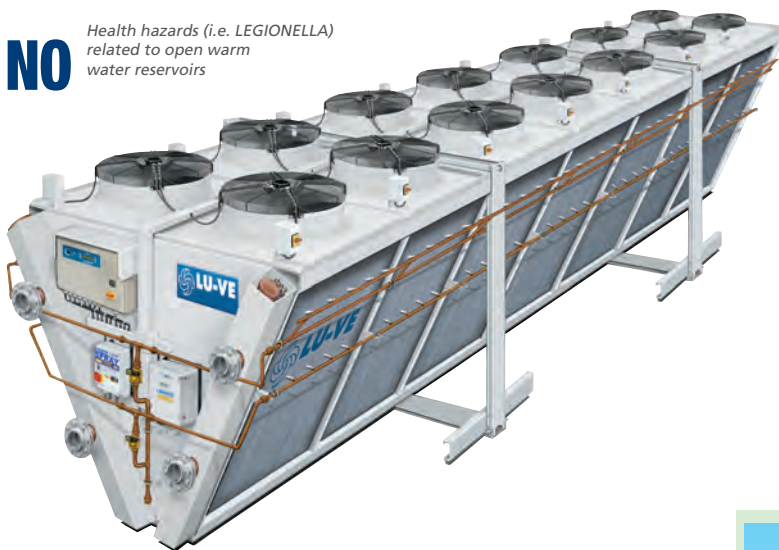

LESS Water consumption!
Energy!
Noise!
Pollution!
Operating cost!

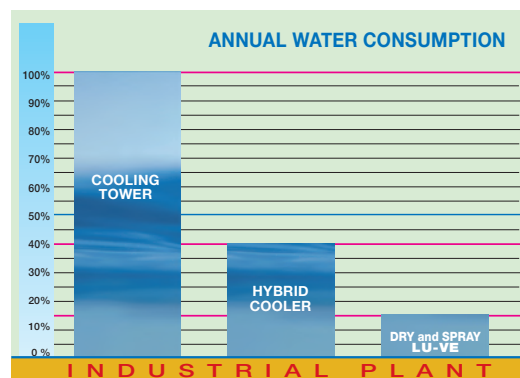
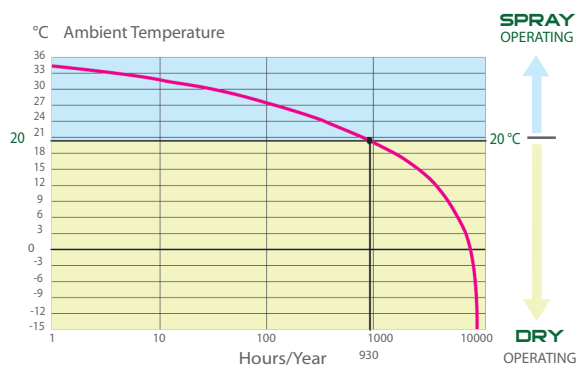

Annual water consumption for a generic industrial installation (on average from 3 to 10 times less than a traditional cooling tower)

W efekcie intensywnych badań, mających na celu zwiększenie efektywności systemu natryskowego, powstała nowa technologia układów zraszających - "Dry & Spray". Ponadprzeciętna wydajność, wynikająca ze szczególnej skuteczności rozpylania wody, pozwoliła na stworzenie produktu o bardzo istotnych walorach, który może być alternatywą dla tradycyjnych wież chłodniczych.

FUNKCJONOWANIE

Urządzenia z systemem "DRY & SPRAY" funkcjonują jak tradycyjne suche jednostki w szerokim zakresie warunków, w których temperatura powietrza jest wystarczająco niska, aby utrzymać wydajność chłodzenia i temperaturę czynnika chłodzonego (lub ciśnienie skraplania) na wymaganym poziomie (tryb pracy na sucho - DRY).

Temperatura przełączenia z trybu działania na sucho (DRY) na tryb pracy na mokro (SPRAY) zależy od konkretnego doboru, ale zwykle kształtuje się w okolicy 20°C.

Ta innowacyjna technologia pozwala na uzyskanie, w zależności od temperatury termometru mokrego powietrza, temperatury płynu chłodzonego równej lub niższej od temperatury termometru suchego powietrza, co generuje znaczące korzyści energetyczne w pracy systemu chłodniczego. Zaawansowany system sterowania, w zależności od potrzeb, zmienia prędkość obrotową wentylatorów oraz ilość natrykiwanej wody.

ZALETY

Zastosowanie suchych chłodziń cieczy oraz skraplaczy z systemem "DRY & SPRAY" jako alternatywy dla tradycyjnych "wież chłodniczych" i "skraplaczy wyparnych" daje następujące korzyści:

- Zużycie wody w trybie SPRAY jest ograniczone do krótkich okresów w ciągu roku. Przez pozostały czas, w trybie DRY, woda nie jest zużywana.
- Brak tacy pod wymiennikiem gromadzącej ciepłą stojącą wodę wyklucza możliwość pojawienia się zanieczyszczeń w wodzie, a w szczególności eliminuje ryzyko powstania i wprowadzenia skażenia biologicznego do środowiska (**brak ryzyka Legionelli**).
- Konstrukcja urządzenia wyklucza wyrzucanie kropelek wody przez wentylatory oraz tworzenie się mgły nad jednostkami.
- Niskie zużycie energii.
- Cicha praca.
- Krótki czas amortyzacji urządzenia.
- Możliwość osiągnięcia wysokich wydajności termicznych w trybie free cooling.

W katalogu dostępne są wymagania co do jakości wody stosowanej do zraszania.

WATER SPRAY SYSTEM

Dla skraplaczy i suchych chłodnic powietrza o dużych wydajnościach.



NO

Health hazards (i.e. LEGIONELLA)
related to open warm
water reservoirs



Najlepsze rozwiązanie do zmaksymalizowania wydajności i zminimalizowania gabarytów urządzeń.

ZASADA DZIAŁANIA

Suche chłodnice cieczy oraz skraplacze są zazwyczaj dobierane przy maksymalnym obciążeniu termicznym i przy maksymalnej temperaturze otoczenia.

Te najtrudniejsze warunki pracy mogą pojawić się jednak tylko przez krótki okres w roku, podczas gdy w pozostałym czasie, przy mniejszym obciążeniu, urządzenie okazuje się przewymiarowane.

Z tych powodów opracowaliśmy nowy produkt, który może być dobrany dla mniej wymagających warunków pracy, ale który może jednocześnie zwiększyć wydajność przy warunkach szczególnie trudnych.

Nowy system polega na zastosowaniu do tradycyjnych suchych chłodnic cieczy i skraplaczy, układu do rozpylania drobnych kropelek wody w kierunku przeciwnym do przepływu powietrza, napływającego na wymiennik.

Poprzez odparowanie wody możliwe jest wstępne schłodzenie powietrza trafiającego na wymiennik i tym samym wzrost wydajności suchych chłodnic cieczy i skraplaczy.

System zraszania nie powinien pracować dłużej niż ok 200 godzin rocznie.

W katalogu dostępne są wymagania, co do jakości wody stosowanej do zraszania.



LESS

Water consumption!
Energy!
Noise!
Pollution!
Operating cost!





Modello	Model	Modèle	Modell	Modelo	Модель	Model
Potenza	Capacity	Puissance	Leistung	Potencia	Мощность	Wydajność
Portata aria	Air quantity	Débit d'air	Luftdurchsatz	Caudal de aire	Объем воздуха	Przepływ powietrza
Fluido refrigerante	Refrigerant fluid	Fluide caloporteur	Kälteträger	Fluido refrigerante	Хладагент	Czynnik chłodniczy
Portata	Flow rate	Débit	Volumenstrom	Caudal	Расход	Przepływ
Perdita di carico	Pressure drop	Perte de charge	Druckverlust	Perdita de carga	Потеря давления	Strata ciśnienia
Elettroventilatori	Fans	Ventilateurs	Ventilatoren	Electroventiladores	Вентиляторы	Wentylatory
Poli	Poles	Pôles	Polig	Polos	Подключение	Pola
Collegamento	Connection	Connexion	Anschluss	Conexión	Подключение	Połączenie
Assorbimento motori	Motor power consumption	Puissance moteurs	Leistungsaufnahme	Consumo motores	Потребление мотора вентилятора	Pobór mocy/prądu silnika
Livello pressione sonora	Sound pressure level	Niveau pression sonore	Schalldruckpegel	Nivel de presión sonora	Уровень шума	Poziom ciśnienia akustycznego
Circuiti	Circuits	Circuits	Kreise	Circuitos	Контур	Obiegi
Volume circuito	Circuit volume	Volume circuit	Rohrinhalt	Volumen circuito	Внутренний объем	Objętość obiegu
Superficie	Surface	Surface	Fläche	Superficie	Поверхность	Powierzchnia
Dimensioni	Dimensions	Dimensions	Abmessungen	Dimensiones	РАЗМЕРЫ	Wymiary
Peso	Weight	Poids	Gewicht	Peso	Вес	Waga
Dati comuni	Common data	Caractéristiques communes	Konstante Daten	Datos comunes	Общие данные	Dane wspólne



SAL Ø 500

60 61

SAL Ø 630

62 63



SAL Ø 800

64 65

▶ XHL Ø 950



66 69

XAL Ø 900-1000

70 73

▶ EHL Ø 950



74 77

EHL Ø 900 - EAL Ø 800-900

78 81



XDHL *Small Giants*

94 95



EHL *Giants*

102 103

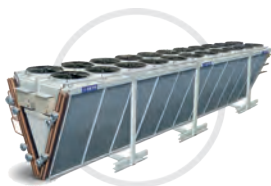

XXLD *Mega Giants*

110 111

AXIAL FAN DRY COOLERS



SAFETUBES SYSTEM® tube protection system



Supersilent / Superefficient



(Dry cooler with accessories)



● **SAL Ø 500**

● **SAL Ø 630**

● **SAL Ø 800**
XAL Ø 900-1000
EHL Ø 900
EAL Ø 800-900

11 - 1285 kW - 352 models

11.0 - 130 kW



Modello	Model	SAL5N (2,1 mm)	4311L	4312L	4321C	4322D	4331C	4332C						
Potenza	Capacity	□ kW (ΔT 15K) Glycol 34%	19,0	17,0	21,0	18,5	38,5	34,0	43,5	37,5	60,5	53,5	65,0	56,0
Fluido refrigerante		m³/h Portata Flowrate	3,6	3,2	3,9	3,5	7,2	6,4	8,1	7,0	11,3	10,0	12,2	10,5
Refrigerant fluid		kPa Perdita di carico Pressure drop	35	28	23	17	28	22	53	40	77	62	52	39
Portata d'aria	Air quantity	m³/h	6800	5700	6400	5200	13600	11400	13200	10400	20400	17100	19800	15600
Assorbimento motori		W	690	540	690	540	1380	1080	1380	1080	2070	1620	2070	1620
Motor power consumption	4P	A	1,4	0,9	1,4	0,9	2,8	1,8	2,8	1,8	4,2	2,7	4,2	2,7
Livello pressione sonora	Sound pressure level	dB (A) (total)	48	44	48	44	51	47	51	47	52	48	52	48
Attacchi	Connections	Ø"	1"		1"		2"		1 1/2"		2"		2"	
Modello	Model	SAL5S (2,1 mm)	4411M		4421D		4431C							
Potenza	Capacity	□ kW (ΔT 15K) Glycol 34%	15,0	13,3		30,5	26,5			45,5	39,6			
Fluido refrigerante		m³/h Portata Flowrate	2,8	2,5		5,7	4,9			8,5	7,4			
Refrigerant fluid		kPa Perdita di carico Pressure drop	57	40		51	35			46	32			
Portata d'aria	Air quantity	m³/h	4400	3700		8800	7400			13200	11100			
Assorbimento motori		W	240	170		480	340			720	510			
Motor power consumption	6P	A	0,6	0,3		1,2	0,6			1,8	0,9			
Livello pressione sonora	Sound pressure level	dB (A) (total)	38	34		41	37			42	38			
Attacchi	Connections	Ø"	1"			1 1/2"				2"				
Modello	Model	SAL5R (2,1 mm)	4511M		4521D		4531C							
Potenza	Capacity	□ kW (ΔT 15K) Glycol 34%	11,0	9,5		22,5	19,0			34,0	28,5			
Fluido refrigerante		m³/h Portata Flowrate	2,1	1,8		4,2	3,6			6,4	5,3			
Refrigerant fluid		kPa Perdita di carico Pressure drop	33	25		30	22			27	20			
Portata d'aria	Air quantity	m³/h	3000	2400		6000	4800			9000	7200			
Assorbimento motori		W	120	80		240	160			360	240			
Motor power consumption	8P	A	0,30	0,15		0,6	0,3			0,9	0,45			
Livello pressione sonora	Sound pressure level	dB (A) (total)	30	25		33	28			34	29			
Attacchi	Connections	Ø"	1"			1 1/2"				2"				
DATI COMUNI / COMMON DATA														
Elettroventilatori		Ø 500 mm x n°	1 o		1 o		2 oo		2 oo		3 ooo		3 ooo	
Fans		Collegamento Connection	△	∧	△	∧	△	∧	△	∧	△	∧	△	∧
Superficie esterna	External surface	m²	36,3		48,4		72,6		96,8		108,9		145,2	
Superficie interna	Internal surface	m²	2,3		3,1		4,6		6,2		6,9		9,3	
Volume circuito	Circuit volume	dm³	7		9		13		17		18		27	
Peso	Weight	kg	56		60		94		102		132		144	

Versioni speciali

Fattori di correzione per versioni speciali
con motori elettrici
1 - 230 V 50 Hz

Special versions

Correction factors for special versions
with fan motors
1 - 230 V 50 Hz

Modello	Type	Ø 500 mm	SALN	SALS	SALR
Potenza	Capacity	kW	0,95	0,99	0,98
Portata d'aria	Air quantity	m³/h	0,92	0,98	0,97
Assorbimento motori		W	0,91	1,01	1
Motor power consumption	1 - 230 V 50 Hz	A	1,97	1,56	1,9
Livello pressione sonora	Sound pressure level	dB (A)	-1	0	0



4346C		4347D		4366C		4367C	
77,0	68,0	87,0	75,0	121,0	107,0	130,0	112,0
14,4	12,8	16,3	14,0	22,6	20,0	24,3	21,0
28	22	53	40	77	62	52	39
27200	22800	26400	20800	40800	34200	39600	31200
2760	2160	2760	2160	4140	3240	4140	3240
5,6	3,6	5,6	3,6	8,4	5,4	8,4	5,4
54	50	54	50	55	51	55	51
2 1/2"		2"		2 1/2"		2 1/2"	
4446D				4466C			
61,0	52,8			90,0	79,2		
11,4	9,9			17,0	14,8		
51	36			46	32		
17600	14800			26400	22200		
960	680			1440	1020		
2,4	1,2			3,6	1,8		
44	40			45	41		
2"				2 1/2"			
4546D				4566C			
45,0	38,0			68,0	57,0		
8,4	7,2			12,8	10,6		
30	22			27	20		
12000	9600			18000	14400		
480	320			720	480		
1,2	0,6			1,8	0,9		
36	31			37	32		
2"				2 1/2"			
4 000		4 000		6 000		6 000	
△	△	△	△	△	△	△	△
145,2		193,6		217,8		290,4	
9,2		12,4		13,8		18,6	
32		34		38		51	
174		190		250		274	

- Potenza con tubi puliti
- Capacity with clean tubes



12.8 - 211 kW



Modello	Model	SAL6N (2,1 mm)	6410D	6411L	6420C	6421C	6430B	6431F	6440B	6441B								
Potenza	Capacity	□ kW (ΔT 15K) Glycol 34%	21	18	25,5	21	43,5	38	51	42	63,5	55	77	64	88	76	103	85
Fluido refrigerante		m ³ /h Portata Flowrate	3,9	3,4	4,7	3,9	8	7	9,6	7,9	11,7	10,3	14,5	11,9	16,4	14,2	19,3	15,9
Refrigerant fluid		kPa Perdita di carico Pressure drop	22	17	37	26	49	38	31	22	24	19	52	37	56	43	29	20
Portata d'aria	Air quantity	m ³ /h	8500	6600	7800	5900	17000	13200	15600	11800	25500	19800	23400	17700	34000	26400	31200	23600
Assorbimento motori		W	550	380	550	380	1100	760	1100	760	1650	1140	1650	1140	2200	1520	2200	1520
Motor power consumption	6P	A	1,2	0,7	1,2	0,7	2,4	1,4	2,4	1,4	3,6	2,1	3,6	2,1	4,8	2,8	4,8	2,8
Livello pressione sonora	Sound pressure level	dB (A) (total)	43	37	43	37	46	40	46	40	47	64	47	41	48	42	48	42
Attacchi	Connections	Ø"	1"	1"	1 1/2"	2"	2"	2"	2"	2"	2"	2"	2"	2"	2"	2"	2 1/2"	2 1/2"
Modello	Model	SAL6S (2,1 mm)	6510L	6511L	6520C	6521C	6530F	6531C	6540B	6541B								
Potenza	Capacity	□ kW (ΔT 15K) Glycol 34%	17	14	19	14,5	34	28,5	38	29	51,5	43	58	44,5	68	57	76	58,5
Fluido refrigerante		m ³ /h Portata Flowrate	3,2	2,6	3,4	2,7	6,2	5,3	7	5,4	9,7	8	10,8	8,3	12,7	10,7	14,2	11
Refrigerant fluid		kPa Perdita di carico Pressure drop	36	28	20	13	29	23	16	11	38	30	47	32	33	24	15	11
Portata d'aria	Air quantity	m ³ /h	5500	4200	5100	3800	11000	8400	10200	7600	16500	12600	15300	11400	22000	16800	20400	15200
Assorbimento motori		W	200	130	200	130	400	260	400	260	600	390	600	390	800	520	800	520
Motor power consumption	8P	A	0,5	0,25	0,5	0,25	1	0,5	1	0,5	1,5	0,75	1,5	0,75	2	1	2	1
Livello pressione sonora	Sound pressure level	dB (A) (total)	35	28	35	28	38	31	38	31	39	32	39	32	40	33	40	33
Attacchi	Connections	Ø"	3/4"	1"	1 1/2"	2"	2"	2"	2"	2"	2"	2"	2"	2"	2"	2"	2 1/2"	2 1/2"
Modello	Model	SAL6R (2,1 mm)	6610L	6620D	6630C	6640F												
Potenza	Capacity	□ kW (ΔT 15K) Glycol 34%	12,8	10	26,1	20,5	39,8	31	53,1	42								
Fluido refrigerante		m ³ /h Portata Flowrate	2,4	1,9	4,9	3,8	7,5	5,7	10	7,9								
Refrigerant fluid		kPa Perdita di carico Pressure drop	23	16	49	32	54	34	53	35								
Portata d'aria	Air quantity	m ³ /h	3600	2600	7200	5200	10800	7800	14400	10400								
Assorbimento motori		W	110	65	220	130	330	195	440	260								
Motor power consumption	12P	A	0,3	0,15	0,6	0,3	0,9	0,45	1,2	0,6								
Livello pressione sonora	Sound pressure level	dB (A) (total)	24	17	27	20	28	21	29	22								
Attacchi	Connections	Ø"	3/4"	1"	1 1/2"	2"												
DATI COMUNI / COMMON DATA																		
Elettroventilatori		Ø 630 mm x n°	1 o	1 o	2 oo	2 oo	3 ooo	3 ooo	4 oooo	4 oooo								
Fans		Collegamento Connection	△	△	△	△	△	△	△	△								
Superficie esterna	External surface	m ²	37,7	56,5	75,4	113,0	113,1	169,5	150,8	226,0								
Superficie interna	Internal surface	m ²	2,4	3,6	4,8	7,2	7,2	10,8	9,6	14,4								
Volume circuito	Circuit volume	dm ³	7	10	13	20	20	29	26	40								
Peso	Weight	kg	113	123	170	185	226	251	298	328								

Versioni speciali

Fattori di correzione per versioni speciali con motori elettrici
1 - 230 V 50 Hz

Special versions

Correction factors for special versions with fan motors
1 - 230 V 50 Hz

Modello	Type	Ø 630 mm	SALN	SALS
Potenza	Capacity	kW	X 1,00	0,93
Portata d'aria	Air quantity	m ³ /h	X 1,00	0,9
Assorbimento motori		W	X 1,08	0,72
Motor power consumption	1 - 230 V 50 Hz	A	X 2,41	1,41
Livello pressione sonora	Sound pressure level	dB (A)	+0	+0



- Potenza con tubi puliti
 - Capacity with clean tubes
- Attacchi lati opposti: A-F
 Connections opposite sides: A-F



6450A		6451B		6445C		6446C		6465B		6466F		6485B		6486B	
105	91	131	108	89	77	105	86	131	114	159	131	180	156	211	174
19,6	17	24,4	20,2	16,6	14,5	19,6	16,1	24,6	21,3	29,8	24,6	33,6	29,1	39,4	32,6
16	12	53	37	62	48	32	23	27	21	50	35	56	43	31	22
42500	33000	39000	29500	34000	26400	31200	23600	51000	39600	46800	35400	68000	52800	62400	47200
2750	1900	2750	1900	2200	1520	2200	1520	3300	2280	3300	2280	4400	3040	4400	3040
6	3,5	6	3,5	4,8	2,8	4,8	2,8	7,2	4,2	7,2	4,2	9,6	5,6	9,6	5,6
49	43	49	43	48	42	48	42	50	44	50	44	51	45	51	45
2 1/2"		2 1/2"		2"		2 1/2"		2 1/2"		2 1/2"		2 1/2"		4"	
6550B		6551B		6545C		6546C		6565F		6566C		6585B		6586B	
87	72	97	73,5	69	58	77	59	105	88	120	90	140	118	156	120
16,2	13,4	18,1	13,7	12,8	10,9	14,3	11	19,6	16,4	22,5	16,8	26,1	22	29,1	22,4
60	45	27	19	36	27	17	12	38	32	46	33	31	27	16	11
27500	21000	25500	19000	22000	16800	20400	15200	33000	25200	30600	22800	44000	33600	40800	30400
1000	650	1000	650	800	520	800	520	1200	780	1200	780	1600	1040	1600	1040
2,5	1,25	2,5	1,25	2	1	2	1	3	1,5	3	1,5	4	2	4	2
41	34	41	34	40	33	40	33	42	35	42	35	43	36	43	36
2"		2 1/2"		2"		2 1/2"		2 1/2"		2 1/2"		2 1/2"		4"	
6650B		6645D		6665C		6685F									
65,8	52			53,5	42			80,4	64			107,4	85		
12,3	9,7			10	7,9			15,1	11,9			20,1	15,9		
39	31			49	33			71	49			55	36		
18000	13000			14400	10400			21600	15600			28800	20800		
550	325			440	260			660	390			880	520		
1,5	0,75			1,2	0,6			1,8	0,9			2,4	1,2		
30	23			29	22			31	24			32	25		
2"		2"		2"		2"		2"		2"		2 1/2"		2"	
5 00000		5 00000		4 0000		4 0000		6 00000		6 00000		8 00000		8 00000	
△	△	△	△	△	△	△	△	△	△	△	△	△	△	△	△
188,5		282,5		150,8		226,0		226,2		339,0		301,6		452,0	
12,0		18,0		9,6		14,4		14,4		21,6		19,2		28,8	
34		48		28		45		44		62		56		88	
355		390		292		322		399		449		522		582	

36 - 927 kW



Modello	Model	SAL8S (2,1 mm)	2111C		2112D		2121B		2122F		2131E		2132E								
Potenza	Capacity	□ kW (ΔT 15K) Glycol 34%		51	43	57	46		102	86	114	92		159	132	171	138				
Fluido refrigerante		m³/h Portata Flowrate		9,6	8,0	10,8	8,7		19,2	16,0	21,3	17,2		29,8	24,7	31,9	25,8				
Refrigerant fluid		kPa Perdita di carico Pressure drop		24	17	49	33		22	16	44	30		53	38	38	26				
Portata d'aria	Air quantity	m³/h		17200	13100	16100	11900		34400	26200	32200	23800		51600	39300	48300	35700				
Assorbimento motori		W		1750	1170	1750	1170		3500	2340	3500	2340		5250	3510	5250	3510				
Motor power consumption	6P	A		3,8	2,2	3,8	2,2		7,6	4,4	7,6	4,4		11,4	6,6	11,4	6,6				
Livello pressione sonora	Sound pressure level	dB (A) (total)		48	42	48	42		50	44	50	44		52	46	52	46				
Attacchi	Connections	Ø"		2"		2"			2 1/2"		2 1/2"			4"		4"					
Modello	Model	SAL8T (2,1 mm)	3110C		3111D		3112D		3120B		3121F		3122F		3130B		3131B		3132B		
Potenza	Capacity	□ kW (ΔT 15K) Glycol 34%	36	31	43	35	45	35	72	62	86	70	90	70	111	95	129	105	135	104	
Fluido refrigerante		m³/h Portata Flowrate	6,7	5,8	8,0	6,5	8,4	6,5	13,4	11,5	16,1	13,1	16,8	13,0	20,8	17,8	24,1	19,6	25,2	19,6	
Refrigerant fluid		kPa Perdita di carico Pressure drop	27	20	45	31	31	20	20	15	40	27	29	18	61	46	44	30	34	21	
Portata d'aria	Air quantity	m³/h	13400	10600	12600	9400	11600	8500	26800	21200	25200	18800	23200	17000	40200	31800	37800	28200	34800	25500	
Assorbimento motori		W	850	540	850	540	850	540	1700	1080	1700	1080	1700	1080	2550	1620	2550	1620	2550	1620	
Motor power consumption	8P	A	2,3	1,1	2,3	1,1	2,3	1,1	4,6	2,2	4,6	2,2	4,6	2,2	6,9	3,3	6,9	3,3	6,9	3,3	
Livello pressione sonora	Sound pressure level	dB (A) (total)	42	36	42	36	42	36	44	38	44	38	44	38	46	40	46	40	46	40	
Attacchi	Connections	Ø"		1 1/2"		2"		2"		2 1/2"		2 1/2"		2 1/2"		2 1/2"		2 1/2"		2 1/2"	
DATI COMUNI / COMMON DATA																					
Elettroventilatori	Fans	Ø 800 mm x n°	1 o		1 o		1 o		2 oo		2 oo		2 oo		3 ooo		3 ooo		3 ooo		
		Collegamento Connection	△	△	△	△	△	△	△	△	△	△	△	△	△	△	△	△	△	△	
Superficie esterna	External surface	m²	65,7		98,6		131,5		131,4		197,2		263,0		197,1		295,8		394,5		
Superficie interna	Internal surface	m²	4,2		6,3		8,4		8,4		12,7		16,9		12,6		19,0		25,3		
VOLUME CIRCUITO	Circuit volume	dm³	11		17		22		21		33		44		28		48		65		
Peso	Weight	kg	230		240		250		350		370		390		470		500		530		

Modello	Model	SAL8S (2,1 mm)	2221B		2222F		2231E		2232E		2241A		2242A								
Potenza	Capacity	□ kW (ΔT 15K) Glycol 34%		204	171	228	184		318	267	342	278		408	345	444	362				
Fluido refrigerante		m³/h Portata Flowrate		38,1	32,0	42,6	34,4		59,5	49,9	64,0	52,0		76,3	64,6	83,1	67,7				
Refrigerant fluid		kPa Perdita di carico Pressure drop		23	17	45	30		53	39	38	26		22	16	20	13				
Portata d'aria	Air quantity	m³/h		68800	52400	64400	47600		103200	78600	96600	71400		137600	104800	128800	95200				
Assorbimento motori		W		7000	4680	7000	4680		10500	7020	10500	7020		14000	9360	14000	9360				
Motor power consumption	6P	A		15,2	8,8	15,2	8,8		22,8	13,2	22,8	13,2		30,4	17,6	30,4	17,6				
Livello pressione sonora	Sound pressure level	dB (A) (total)		53	47	53	47		54	48	54	48		55	49	55	49				
Attacchi	Connections	Ø"		4"		4"			2 x 4"		2 x 4"			2 x 4"		2 x 4"					
Modello	Model	SAL8T (2,1 mm)	3220E		3221F		3222F		3230E		3231B		3232B		3240N		3241A		3242E		
Potenza	Capacity	□ kW (ΔT 15K) Glycol 34%	144	123	172	140	180	139	225	193	261	212	272	211	290	249	338	275	367	284	
Fluido refrigerante		m³/h Portata Flowrate	26,9	23,1	32,2	26,2	33,7	26,1	42,0	36,1	48,8	39,5	50,9	39,4	54,2	46,6	63,1	51,4	68,6	53,1	
Refrigerant fluid		kPa Perdita di carico Pressure drop	20	15	40	28	29	18	62	47	46	31	36	23	30	22	15	10	54	34	
Portata d'aria	Air quantity	m³/h	53600	42400	50400	37600	46400	34000	80400	63600	75600	56400	69600	51000	107200	84800	100800	75200	92800	68000	
Assorbimento motori		W	3400	2160	3400	2160	3400	2160	5100	3240	5100	3240	5100	3240	6800	4320	6800	4320	6800	4320	
Motor power consumption	8P	A	9,2	4,4	9,2	4,4	9,2	4,4	13,8	6,6	13,8	6,6	13,8	6,6	18,4	8,8	18,4	8,8	18,4	8,8	
Livello pressione sonora	Sound pressure level	dB (A) (total)	47	41	47	41	47	41	48	42	48	42	48	42	49	43	49	43	49	43	
Attacchi	Connections	Ø"	2 x 2 1/2"		4"		4"		2 x 2 1/2"		4"		4"		2 x 2 1/2"		2 x 4"		2 x 4"		
DATI COMUNI / COMMON DATA																					
Elettroventilatori	Fans	Ø 800 mm x n°	4 ○○		4 ○○		4 ○○		6 ○○○		6 ○○○		6 ○○○		8 ○○○○		8 ○○○○		8 ○○○○		
		Collegamento Connection	△	△	△	△	△	△	△	△	△	△	△	△	△	△	△	△	△	△	
Superficie esterna	External surface	m²	262,8		394,4		526,0		394,2		591,6		789,0		525,6		788,8		1052,0		
Superficie interna	Internal surface	m²	16,8		25,3		33,8		25,2		38,0		50,7		33,6		50,7		67,6		
VOLUME CIRCUITO	Circuit volume	dm³	43		66		86		56		96		130		86		132		172		
Peso	Weight	kg	610		650		690		880		940		1000		1130		1210		1290		

- Potenza con tubi puliti Attacchi lati opposti: A-F-N
- Capacity with clean tubes Connections opposite sides: A-F-N



		2141A		2142A				2151A		2152A			
		204	171	222	179			262	220	282	230		
		38,0	31,9	41,4	33,5			49,0	41,1	52,6	43,0		
		22	16	20	13			40	29	35	23		
		68800	52400	64400	47600			86000	65500	80500	59500		
		7000	4680	7000	4680			8750	5850	8750	5850		
		15,2	8,8	15,2	8,8			19,0	11,0	19,0	11,0		
		53	47	53	47			53	47	53	47		
		4"		4"				4"		4"			
		3140A		3141A		3142E		3150A		3151A		3152A	
		144	123	167	136	182	141	185	159	215	174	225	174
		26,9	23,1	31,3	25,4	34,0	26,3	34,5	29,6	40,1	32,7	42,0	32,6
		30	22	15	10	53	34	53	40	27	19	22	14
		53600	42400	50400	37600	46400	34000	67000	53000	63000	47000	58000	42500
		3400	2160	3400	2160	3400	2160	4250	2700	4250	2700	4250	2700
		9,2	4,4	9,2	4,4	9,2	4,4	11,5	5,5	11,5	5,5	11,5	5,5
		47	41	47	41	47	41	47	41	47	41	47	41
		2 1/2"		4"		4"		2 1/2"		4"		4"	
		4 0000		4 0000		4 0000		5 00000		5 00000		5 00000	
		△	△	△	△	△	△	△	△	△	△	△	△
		262,8		394,4		526,0		328,5		493,0		657,5	
		16,8		25,3		33,8		21		31,7		42,2	
		43		66		86		53		81		106	
		600		640		680		730		780		830	



		2251A		2252A				2261N		2262N				2271N		2272N				2281N		2282N			
		524	444	564	464			633	539	686	562			745	634	806	660			857	729	927	758		
		97,9	83,0	105,5	86,7			118,3	100,7	128,2	105,1			139,2	118,4	150,7	123,4			160,2	136,3	173,4	141,8		
		40	29	35	24			54	39	41	28			82	60	62	42			117	86	88	60		
		172000	131000	161000	119000			206400	157200	193200	142800			240800	183400	225400	166600			275200	209600	257600	190400		
		17500	11700	17500	11700			21000	14040	21000	14040			24500	16380	24500	16380			28000	18720	28000	18720		
		38,0	22,0	38,0	22,0			45,6	26,4	45,6	26,4			53,2	30,8	53,2	30,8			60,8	35,2	60,8	35,2		
		56	50	56	50			57	51	57	51			58	52	58	52			58	52	58	52		
		2 x 4"		2 x 4"				3 x 4"		3 x 4"				3 x 4"		3 x 4"				3 x 4"		3 x 4"			
		3250N		3251A		3252A		3260N		3261A		3262A		3270N		3271N		3272N		3280N		3281N		3282N	
		373	320	434	352	454	352	454	389	526	427	550	426	535	458	619	502	646	500	615	527	712	577	742	573
		69,7	59,9	81,1	65,8	84,8	65,8	84,8	72,8	98,4	79,9	102,8	79,6	100,0	85,7	115,8	93,9	120,8	93,5	115,0	98,6	133,1	107,8	138,7	107,2
		53	40	28	19	23	14	60	46	45	30	36	22	86	65	57	39	40	25	124	94	82	56	57	36
		134000	106000	126000	94000	116000	85000	160800	127200	151200	112800	139200	102000	187600	148400	176400	131600	162400	119000	214400	169600	201600	150400	185600	136000
		8500	5400	8500	5400	8500	5400	10200	6480	10200	6480	10200	6480	11900	7560	11900	7560	11900	7560	13600	8640	13600	8640	13600	8640
		23,0	11,0	23,0	11,0	23,0	11,0	27,6	13,2	27,6	13,2	27,6	13,2	32,2	15,4	32,2	15,4	32,2	15,4	36,8	17,6	36,8	17,6	36,8	17,6
		50	44	50	44	50	44	51	45	51	45	51	45	52	46	52	46	52	46	52	46	52	46	52	46
		2 x 2 1/2"		2 x 4"		2 x 4"		2 x 4"		2 x 4"		2 x 4"		3 x 4"		3 x 4"		3 x 4"		3 x 4"		3 x 4"		3 x 4"	
		10 00000		10 00000		10 00000		12 00000		12 00000		12 00000		14 00000		14 00000		14 00000		16 00000		16 00000		16 00000	
		△	△	△	△	△	△	△	△	△	△	△	△	△	△	△	△	△	△	△	△	△	△	△	△
		657,0		986,0		1315,0		788		1183		1577		920		1380		1840		1051		1577		2102	
		42		63,4		84,5		50,6		76,0		101,2		59,1		88,7		118,2		67,6		101,4		135,2	
		108		162		212		162		223		283		182		253		323		202		283		363	
		1390		1490		1590		1730		1850		1980		2000		2140		2280		2260		2430		2590	

45 - 651 kW

New



Modello	Model	XHL95F (2,1 mm)	4117C	6119C	4127B	6129E
Potenza	Capacity	<input type="checkbox"/> kW (ΔT 15K) Glycol 34%	95	102	191	207
Fluido refrigerante		m ³ /h Portata Flowrate	18,4	19,8	37,4	40,6
Refrigerant fluid		kPa Perdita di carico Pressure drop	75	61	61	40
Portata d'aria	Air quantity	m ³ /h	29100	27600	58200	55200
Assorbimento motori		W	2637	2730	5274	5460
Motor power consumption	400V - 3ph - 50Hz	A	4,6	4,6	9,2	9,2
Livello pressione sonora	Sound pressure level	dB (A) (Total)	55	55	57	57
Attacchi	Connections	Ø"	2	2	2 1/2	4
Modello	Model	XHL95N (2,1 mm)	1113C	7114C	1123B	7124E
Potenza	Capacity	<input type="checkbox"/> kW (ΔT 15K) Glycol 34%	89	95	179	192
Fluido refrigerante		m ³ /h Portata Flowrate	17,3	18,4	35,1	37,6
Refrigerant fluid		kPa Perdita di carico Pressure drop	67	54	55	35
Portata d'aria	Air quantity	m ³ /h	26500	25100	53000	50200
Assorbimento motori		W	2040	2110	4080	4220
Motor power consumption	400V - 3ph - 50Hz	A	3,5	3,5	7	7
Livello pressione sonora	Sound pressure level	dB (A) (Total)	52	52	54	54
Attacchi	Connections	Ø"	2	2	2 1/2	4
DATI COMUNI / COMMON DATA						
Elettroventilatori	Fans	Ø 950 mm x n°	1 o	1 o	2 oo	2 oo
Superficie esterna	TURBOCOIL External surface	m ²	182,5	243,3	365,0	486,6
Superficie interna	Internal surface	m ²	10,1	13,5	20,3	27,0
Volume circuito	Circuit volume	dm ³	30,2	38,3	64,8	88,7
Peso	Weight	kg	301,0	321,0	522,0	564,0

Modello	Model	XHL95X (2,1 mm)	7113C	7117C	6115D	7123E	7127B	6125B
Potenza	Capacity	<input type="checkbox"/> kW (ΔT 15K) Glycol 34%	57	62	65	113	124	127
Fluido refrigerante		m ³ /h Portata Flowrate	11,1	12	12,6	21,9	24,1	24,6
Refrigerant fluid		kPa Perdita di carico Pressure drop	63	35	59	43	28	20
Portata d'aria	Air quantity	m ³ /h	17400	16100	15900	34800	32200	31800
Assorbimento motori		W	530	560	570	1060	1120	1140
Motor power consumption	400V - 3ph - 50Hz	A	0,9	0,9	0,9	1,8	1,8	1,8
Livello pressione sonora	Sound pressure level	dB (A) (Total)	39	39	39	41	41	41
Attacchi	Connections	Ø"	1 1/2	2	2	2 1/2	2 1/2	2 1/2
Modello	Model	XHL95U (2,1 mm)	5119C	8113C	5129E	8123B		
Potenza	Capacity	<input type="checkbox"/> kW (ΔT 15K) Glycol 34%	45	47	90	95		
Fluido refrigerante		m ³ /h Portata Flowrate	8,7	9,1	17,5	18,4		
Refrigerant fluid		kPa Perdita di carico Pressure drop	42	21	29	17		
Portata d'aria	Air quantity	m ³ /h	12500	11500	25000	23000		
Assorbimento motori		W	220	230	440	460		
Motor power consumption	400V - 3ph - 50Hz	A	0,5	0,5	1	1		
Livello pressione sonora	Sound pressure level	dB (A) (Total)	32	32	34	34		
Attacchi	Connections	Ø"	1 1/2	2	2 1/2	2 1/2		
DATI COMUNI / COMMON DATA								
Elettroventilatori	Fans	Ø 950 mm x n°	1 o	1 o	1 o	2 oo	2 oo	2 oo
Superficie esterna	TURBOCOIL External surface	m ²	121,7	182,5	210,7	243,4	365,0	421,4
Superficie interna	Internal surface	m ²	6,8	10,1	13,5	13,5	20,3	27,0
Volume circuito	Circuit volume	dm ³	19,8	30,2	38,3	48,7	64,8	80,9
Peso	Weight	kg	276,0	301,0	321,0	465,0	522,0	564,0

- Potenza con tubi puliti
- Capacity with clean tubes

Attacchi lati opposti: **A-F-N**
 Connections opposite sides: **A-F-N**



	4137A	6139A		4147A	6149A		4157N	6159N	4167N	6169N
	279	304		384	417		492	533	601	651
	54,7	59,6		76	82,5		98,3	106,4	121,2	131,3
	36	35		75	71		95	71	158	117
	87300	82800		116400	110400		145500	138000	174600	165600
	7911	8190		10548	10920		13185	13650	15822	16380
	13,8	13,8		18,4	18,4		23	23	27,6	27,6
	59	59		59	59		60	60	61	61
	4	4		4	4		2x4	2x4	2x4	2x4
	1133A	7134A		1143A	7144A		1153N	7154N	1163N	7164N
	263	283		362	388		462	496	565	606
	51,5	55,4		71,6	76,8		92,3	99,1	113,9	122,2
	32	31		67	62		85	62	142	103
	79500	75300		106000	100400		132500	125500	159000	150600
	6120	6330		8160	8440		10200	10550	12240	12660
	10,5	10,5		14	14		17,5	17,5	21	21
	56	56		56	56		57	57	58	58
	4	4		4	4		2x4	2x4	2x4	2x4
	3 000	3 000		4 0000	4 0000		5 00000	5 00000	6 000000	6 000000
	547,5	729,9		730,0	973,2		912,5	1216,5	1095,0	1459,8
	30,4	40,6		40,6	54,1		50,7	67,6	60,9	81,1
	96,7	120,8		120,8	153,0		145,0	185,2	169,1	217,4
	733,0	795,0		971,0	1053,0		1192,0	1297,0	1416,0	1539,0

	7133A	7137B	6135B	7143A	7147A	6145A	7153N	7157A	6155A	7167A	6165A
	167	192	195	228	251	256	291	320	326	391	398
	32,7	37,6	38,2	44,7	49,2	50,2	57,6	63,3	64,5	78,1	79,5
	27	82	57	57	34	28	77	60	49	97	77
	52200	48300	47700	69600	64400	63600	87000	80500	79500	96600	95400
	1590	1680	1710	2120	2240	2280	2650	2800	2850	3360	3420
	2,7	2,7	2,7	3,6	3,6	3,6	4,5	4,5	4,5	5,4	5,4
	43	43	43	43	43	43	44	44	44	45	45
	2 ½	2 ½	2 ½	2 ½	4	4	2x 2 ½	4	4	4	4
	5139A	8133B		5149A	8143A		5159N	8153A		8163A	
	133	144		182	191		233	243		294	
	25,8	27,9		35,7	37,4		46,1	48,1		58,2	
	18	49		37	20		51	36		58	
	37500	34500		50000	46000		62500	57500		69000	
	660	690		880	920		1100	1150		1380	
	1,5	1,5		2	2		2,5	2,5		3	
	36	36		36	36		37	37		38	
	2 ½	2 ½		2 ½	4		2x 2 ½	4		4	
	3 000	3 000	3 000	4 0000	4 0000	4 0000	5 00000	5 00000	5 00000	6 000000	6 000000
	365,1	547,5	632,1	486,8	730,0	842,8	608,5	912,5	1053,5	1095,0	1264,2
	20,3	30,4	40,6	27,0	40,6	54,1	33,8	50,7	67,6	60,9	81,1
	64,8	88,9	113,0	80,9	120,8	153,0	97,0	145,0	185,2	169,1	217,4
	664,0	733,0	795,0	878,0	971,0	1053,0	1078,0	1192,0	1297,0	1416,0	1539,0

XHL Ø 950

Raffreddatori di liquido
Dry coolers



183 - 1330 kW

New



Modello	Model	XHL95F (2,1 mm)	4228B	6229B	4238A	6239A
Potenza	Capacity	<input type="checkbox"/> kW (ΔT 15K) Glycol 34%	386	419	577	627
Fluido refrigerante		m ³ /h Portata Flowrate	76,4	82,9	116,3	126,4
Refrigerant fluid		kPa Perdita di carico Pressure drop	78	73	37	36
Portata d'aria	Air quantity	m ³ /h	116400	110400	174600	165600
Assorbimento motori		W	10548	10920	15822	16380
Motor power consumption	400V - 3ph - 50Hz	A	18,4	18,4	27,6	27,6
Livello pressione sonora	Sound pressure level	dB (A) (Total)	59	59	61	61
Attacchi	Connections	Ø"	4	4	2x4	2x4
Modello	Model	XHL95N (2,1 mm)	6223B	6224B	6233A	6234A
Potenza	Capacity	<input type="checkbox"/> kW (ΔT 15K) Glycol 34%	363	390	543	584
Fluido refrigerante		m ³ /h Portata Flowrate	71,8	77,1	109,5	117,7
Refrigerant fluid		kPa Perdita di carico Pressure drop	69	64	33	32
Portata d'aria	Air quantity	m ³ /h	106000	100400	159000	150600
Assorbimento motori		W	8160	8440	12240	12660
Motor power consumption	400V - 3ph - 50Hz	A	14	14	21	21
Livello pressione sonora	Sound pressure level	dB (A) (Total)	56	56	58	58
Attacchi	Connections	Ø"	4	4	2x4	2x4
DATI COMUNI / COMMON DATA						
Elettroventilatori	Fans	Ø 950 mm x n°	4 00	4 00	6 000	6 000
Superficie esterna	TURBOCOIL External surface	m ²	730,0	973,2	1095,0	1459,8
Superficie interna	Internal surface	m ²	40,6	54,1	60,9	81,2
Volume circuito	Circuit volume	dm ³	145,2	177,4	193,5	241,8
Peso	Weight	kg	917,0	1006,0	1328,0	1462,0

Modello	Model	XHL95X (2,1 mm)	7223B	7227B	1225F	7233A	7237E	1235E
Potenza	Capacity	<input type="checkbox"/> kW (ΔT 15K) Glycol 34%	229	252	261	342	393	400
Fluido refrigerante		m ³ /h Portata Flowrate	44,9	49,4	51,1	68,3	78,5	79,9
Refrigerant fluid		kPa Perdita di carico Pressure drop	59	35	57	28	76	50
Portata d'aria	Air quantity	m ³ /h	69600	64400	63600	104400	96600	95400
Assorbimento motori		W	2120	2240	2280	3180	3360	3420
Motor power consumption	400V - 3ph - 50Hz	A	3,6	3,6	3,6	5,4	5,4	5,4
Livello pressione sonora	Sound pressure level	dB (A) (Total)	43	43	43	45	45	45
Attacchi	Connections	Ø"	2 ½	4	4	2x 2 ½	2x4	2x4
Modello	Model	XHL95U (2,1 mm)	5229B	8223B	5239A	8233E		
Potenza	Capacity	<input type="checkbox"/> kW (ΔT 15K) Glycol 34%	183	192	272	295		
Fluido refrigerante		m ³ /h Portata Flowrate	35,9	37,6	53,8	58,4		
Refrigerant fluid		kPa Perdita di carico Pressure drop	39	21	18	46		
Portata d'aria	Air quantity	m ³ /h	50000	46000	75000	69000		
Assorbimento motori		W	880	920	1320	1380		
Motor power consumption	400V - 3ph - 50Hz	A	2	2	3	3		
Livello pressione sonora	Sound pressure level	dB (A) (Total)	36	36	38	38		
Attacchi	Connections	Ø"	2 ½	4	2x 2 ½	2x4		
DATI COMUNI / COMMON DATA								
Elettroventilatori	Fans	Ø 950 mm x n°	4 00	4 00	4 00	6 000	6 000	6 000
Superficie esterna	TURBOCOIL External surface	m ²	486,8	730,0	842,8	730,2	1095,0	1264,2
Superficie interna	Internal surface	m ²	27,1	40,6	54,1	40,6	60,9	81,2
Volume circuito	Circuit volume	dm ³	97,4	145,2	177,4	129,6	193,5	241,8
Peso	Weight	kg	819,0	917,0	1006,0	1168,0	1328,0	1462,0



Potenza con tubi puliti
 Capacity with clean tubes

Attacchi lati opposti: A-F-N
 Connections opposite sides: A-F-N

	4248A	6249A		4258N	6259N	4268N	6269N
	795	861		1016	1100	1231	1330
	161,8	175,2		208,7	226	252,9	273,2
	77	73		108	85	176	137
	232800	220800		291000	276000	349200	331200
	21096	21840		26370	27300	31644	32760
	36,8	36,8		46	46	55,2	55,2
	62	62		63	63	64	64
	2x4	2x4		3x4	3x4	3x4	3x4
	6243A	6244A		6253N	6254N	6263N	6264N
	747	802		955	1024	1157	1238
	152	163,2		196,2	210,4	237,7	254,3
	69	64		96	75	157	120
	212000	200800		265000	251000	318000	301200
	16320	16880		20400	21100	24480	25320
	28	28		35	35	42	42
	59	59		60	60	61	61
	2x4	2x4		3x4	3x4	3x4	3x4
	8	8	10	10	10	12	12
	1460,0	1946,4		1825,0	2433,0	2190,0	2919,6
	81,2	108,2		101,5	135,3	121,8	162,4
	241,8	306,2		290,1	370,6	338,4	435,0
	1723,0	1898,0		2137,0	2360,0	2563,0	2831,0

	7243A	7247A	1245A	7253N	7257A	1255A	7267A	1265A
	471	519	529	602	662	674	808	822
	95	104,6	106,7	122,5	134,7	137,2	166	168,9
	59	35	29	88	63	51	101	80
	139200	128800	127200	174000	161000	159000	193200	190800
	4240	4480	4560	5300	5600	5700	6720	6840
	7,2	7,2	7,2	9	9	9	10,8	10,8
	46	46	46	47	47	47	48	48
	2x 2 1/2	2x4	2x4	2x4	2x4	2x4	2x4	2x4
	5249A	8243A		5259N	8253A		8263A	
	374	391		477	498		602	
	74,7	78,1		96,2	100,4		121,4	
	39	21		58	37		59	
	100000	92000		125000	115000		138000	
	1760	1840		2200	2300		2760	
	4	4		5	5		6	
	39	39		40	40		41	
	2x 2 1/2	2x4		2x4	2x4		2x4	
	8	8	8	10	10	10	12	12
	973,6	1460,0	1685,6	1217,0	1825,0	2107,0	2190,0	2528,4
	54,1	81,2	108,2	67,7	101,5	135,3	121,8	162,4
	161,8	241,8	306,2	209,6	290,1	370,6	338,4	435,0
	1524,0	1723,0	1898,0	1892,0	2137,0	2360,0	2563,0	2831,0

XAL Ø 900 - 1000

Raffreddatori di liquido
Dry coolers



37 - 641 kW



Modello	Model	XAL9K (2,1 mm)	2911C		3911C		2912B		3912E	
Potenza	Capacity	□ kW (ΔT 15K) Glycol 34%	90	74	100	80	181	149	202	161
Fluido refrigerante		m ³ /h Portata Flowrate	16,8	13,9	18,7	14,9	33,8	27,9	37,7	30,1
Refrigerant fluid		kPa Perdita di carico Pressure drop	65	45	55	36	63	44	37	24
Portata d'aria	Air quantity	m ³ /h	30800	22700	29400	21600	61600	45400	58800	43200
Assorbimento motori		W	4590	2790	4590	2790	9180	5580	9180	5580
Motor power consumption		A	8	4,6	8	4,6	16	9,2	16	9,2
Livello pressione sonora	Sound pressure level	dB (A) (Total)	62	53	62	53	64	55	64	55
Attacchi	Connections	Ø"	2		2		2 ½		4	
Modello	Model	XAL9N (2,1 mm)	5911C		6911C		5912B		6912E	
Potenza	Capacity	□ kW (ΔT 15K) Glycol 34%	78	65	85	68	157	131	170	137
Fluido refrigerante		m ³ /h Portata Flowrate	14,6	12,1	15,9	12,8	29,4	24,5	31,8	25,6
Refrigerant fluid		kPa Perdita di carico Pressure drop	50	36	41	27	48	35	27	18
Portata d'aria	Air quantity	m ³ /h	24500	18800	23300	17500	49000	37600	46600	35000
Assorbimento motori		W	2300	1560	2370	1580	4600	3120	4740	3160
Motor power consumption		A	5,1	2,9	5,1	2,9	10,2	5,8	10,2	5,8
Livello pressione sonora	Sound pressure level	dB (A) (Total)	54	46	54	46	56	48	56	48
Attacchi	Connections	Ø"	2		2		2 ½		4	
Modello	Model	XAL9X (2,1 mm)	7911C	8911C	9911D	7912E	8912B	9912B		
Potenza	Capacity	□ kW (ΔT 15K) Glycol 34%	51	43	58	46	102	86	117	93
Fluido refrigerante		m ³ /h Portata Flowrate	9,5	8	10,8	8,6	19,1	16,1	21,9	17,4
Refrigerant fluid		kPa Perdita di carico Pressure drop	50	36	29	19	49	30	37	27
Portata d'aria	Air quantity	m ³ /h	17000	13000	16000	12000	34000	26000	32000	24000
Assorbimento motori		W	820	520	820	520	1640	1040	1640	1040
Motor power consumption		A	2,2	1,15	2,2	1,15	4,4	2,3	4,4	2,3
Livello pressione sonora	Sound pressure level	dB (A) (Total)	43	36	43	36	45	38	45	38
Attacchi	Connections	Ø"	1 ½	2	2	2	2 ½	2 ½	2 ½	2 ½
Modello	Model	XAL9U (2,1 mm)	1911C	4911C	1912E		4912B			
Potenza	Capacity	□ kW (ΔT 15K) Glycol 34%	37	31	39	32	75	62	78	64
Fluido refrigerante		m ³ /h Portata Flowrate	7	5,8	7,3	6	14	11,5	14,6	11,9
Refrigerant fluid		kPa Perdita di carico Pressure drop	28	20	14	10	21	15	13	9
Portata d'aria	Air quantity	m ³ /h	10600	8400	10000	7800	21200	16800	20000	15600
Assorbimento motori		W	270	166	270	171	540	332	540	342
Motor power consumption		A	0,8	0,4	0,8	0,4	1,6	0,8	1,6	0,8
Livello pressione sonora	Sound pressure level	dB (A) (Total)	32	26	32	26	34	28	34	28
Attacchi	Connections	Ø"	1 ½"	2"	2 ½"		2 ½"			

DATI COMUNI / COMMON DATA

		Ø 900 mm x n°	1 o		1 o		1 o		2 oo		2 oo		2 oo	
		Collegamento	Connection		△	∩	△	∩	△	∩	△	∩	△	∩
Elettroventilatori	Fans													
Superficie esterna	TURBOCOIL External surface	m ²	105,2		157,8		210,4		210,4		315,6		420,7	
Superficie interna	Internal surface	m ²	6,8		10,2		13,6		13,6		20,4		27,1	
Volume circuito	Circuit volume	dm ³	19,8		30,2		38,5		43,2		59,6		75,9	
Peso	Weight	kg	263		287		306		443		497		537	

Modello	Model	XAL10N (2,1 mm)	2711C		3711C		2712B		3712E	
Potenza	Capacity	□ kW (ΔT 15K) Glycol 34%	83	73	91	77	168	147	183	156
Fluido refrigerante		m ³ /h Portata Flowrate	15,5	13,7	17,1	14,4	31,3	27,5	34,3	29,1
Refrigerant fluid		kPa Perdita di carico Pressure drop	56	44	46	34	55	43	31	23
Portata d'aria	Air quantity	m ³ /h	27200	22200	25700	20600	54400	44400	51400	41200
Assorbimento motori		W	2390	1820	2450	1820	4780	3640	4900	3640
Motor power consumption		A	5,7	3,3	5,7	3,3	11,4	6,6	11,4	6,6
Livello pressione sonora	Sound pressure level	dB (A) (Total)	54	49	54	49	56	51	56	51
Attacchi	Connections	Ø"	2		2		2 ½		4	

DATI COMUNI / COMMON DATA

		Ø 1000 mm x n°	1 o		1 o		1 o		2 oo		2 oo		2 oo	
		Collegamento	Connection		△	∩	△	∩	△	∩	△	∩	△	∩
Elettroventilatori	Fans													
Superficie esterna	TURBOCOIL External surface	m ²	105,2		157,8		210,4		210,4		315,6		420,7	
Superficie interna	Internal surface	m ²	6,8		10,2		13,6		13,6		20,4		27,1	
Volume circuito	Circuit volume	dm ³	19,8		30,2		38,5		43,2		59,6		75,9	
Peso	Weight	kg	263		287		306		443		497		537	

Potenza con tubi puliti Attacchi lati opposti: A-F-N
 Capacity with clean tubes Connections opposite sides: A-F-N



		2913A		3913A				2914A		3914A				2915N		3915N		2916N		3916N	
		267	221	299	239			368	304	411	328			471	389	525	419	577	476	641	511
		49,9	41,3	55,8	44,7			68,9	56,9	76,8	61,4			88,2	72,7	98,2	78,3	107,7	88,9	119,8	95,7
		31	22	32	21			67	47	66	43			86	61	68	45	145	102	112	74
		92400	68100	88200	64800			123200	90800	117600	86400			154000	113500	147000	108000	184800	136200	176400	129600
		13770	8370	13770	8370			18360	11160	18360	11160			22950	13950	22950	13950	27540	16740	27540	16740
		24	13,8	24	13,8			32	18,4	32	18,4			40	23	40	23	48	27,6	48	27,6
		66	57	66	57			66	57	66	57			67	58	67	58	68	59	68	59
		4		4				4		4				2x 4		2x 4		2x 4		2x 4	

		5913A		6913A				5914A		6914A				5915N		6915N		5916N		6916N	
		232	195	253	204			320	268	347	277			409	342	443	350	500	417	541	423
		43,5	36,4	47,3	38,2			59,9	50,1	64,9	51,8			76,5	63,9	82,9	65,4	93,5	78	101,2	79
		24	17	24	16			51	37	48	31			67	48	50	32	112	81	83	52
		73500	56400	69900	52500			98000	75200	93200	70000			122500	94000	116500	87500	147000	112800	139800	105000
		6900	4680	7110	4740			9200	6240	9480	6320			11500	7800	11850	7900	13800	9360	14220	9480
		15,3	8,7	15,3	8,7			20,4	11,6	20,4	11,6			25,5	14,5	25,5	14,5	30,6	17,4	30,6	17,4
		58	50	58	50			58	50	58	50			59	51	59	51	60	52	60	52
		4		4				4		4				2x 4		2x 4		2x 4		2x 4	

		7913A		8913B		9913B		7914A		8914A		9914A		7915N		8915A		9915A		8916A		9916A	
		151	127	180	144	181	138	207	174	237	189	238	182	264	221	299	239	300	229	364	289	369	276
		28,1	23,8	33,6	26,9	33,8	25,8	38,7	32,5	44,2	35,3	44,5	34	49,2	41,2	55,9	44,6	56,1	42,8	67,9	53,9	68,9	51,6
		29	21	80	53	58	35	60	43	29	19	23	14	67	48	51	34	40	24	83	54	65	37
		51000	39000	48000	36000	45300	33300	68000	52000	64000	48000	60400	44400	85000	65000	80000	60000	75500	55500	96000	72000	90600	66600
		2460	1560	2460	1560	2550	1590	3280	2080	3280	2080	3400	2120	4100	2600	4100	2600	4250	2650	4920	3120	5100	3180
		6,6	3,45	6,6	3,45	6,6	3,45	8,8	4,6	8,8	4,6	8,8	4,6	11	5,75	11	5,75	11	5,75	13,2	6,9	13,2	6,9
		47	40	47	40	47	40	47	40	47	40	47	40	48	41	48	41	48	41	49	42	49	42
		2 1/2		2 1/2		2 1/2		2 1/2		4		4		2x 2 1/2		4		4		4		4	

		1913A		4913B				1914A		4914A				1915N		4915A				4916A	
		111	93	119	97			153	126	157	127			195	160	198	160			239	193
		20,8	17,4	22,3	18,1			28,6	23,6	29,3	23,8			36,6	29,9	36,9	30			44,6	36,2
		16	12	37	25			34	23	13	9			39	27	24	16			38	26
		31800	25200	30000	23400			42400	33600	40000	31200			53000	42000	50000	39000			60000	46800
		810	498	810	513			1080	664	1080	684			1350	830	1350	855			1620	1026
		2,4	1,2	2,4	1,2			3,2	1,6	3,2	1,6			4	2	4	2			4,8	2,4
		36	30	36	30			36	30	36	30			37	31	37	31			38	32
		2 1/2"		2 1/2"				2 1/2"		4"				2x 2 1/2"		4"				4"	

		3 000		3 000		3 000		4 0000		4 0000		4 0000		5 00000		5 00000		5 00000		6 000000		6 000000	
		△	△	△	△	△	△	△	△	△	△	△	△	△	△	△	△	△	△	△	△	△	
		315,6		473,3		631,1		420,7		631,1		841,5		525,9		788,9		1051,9		946,7		1262,2	
		20,4		30,5		40,7		27,1		40,7		54,3		33,9		50,9		67,9		61,1		81,4	
		59,3		83,7		108,1		75,3		119,3		151,8		91,4		143,5		183,9		167,6		216,1	
		632		698		757		836		925		1003		1027		1135		1235		1349		1466	

		2713A		3713A				2714A		3714A				2715N		3715N		2716N		3716N	
		248	218	272	231			341	300	374	317			436	383	478	405	534	468	583	489
		46,3	40,8	50,9	43,3			63,8	56,1	69,9	59,3			81,6	71,7	89,4	75,7	99,8	87,5	109	91,5
		27	21	27	20			58	45	56	41			75	59	57	42	126	100	95	69
		81600	66600	77100	61800			108800	88800	102800	82400			136000	111000	128500	103000	163200	133200	154200	123600
		7170	5460	7350	5460			9560	7280	9800	7280			11950	9100	12250	9100	14340	10920	14700	10920
		17,1	9,9	17,1	9,9			22,8	13,2	22,8	13,2			28,5	16,5	28,5	16,5	34,2	19,8	34,2	19,8
		58	53	58	53			58	53	58	53			59	54	59	54	60	55	60	55
		4		4				4		4				2x 4		2x 4		2x 4		2x 4	

		3 000		3 000		3 000		4 0000		4 0000		4 0000		5 00000		5 00000		5 00000		6 000000		6 000000	
		△	△	△	△	△	△	△	△	△	△	△	△	△	△	△	△	△	△	△	△	△	
		315,6		473,3		631,1		420,7		631,1		841,5		525,9		788,9		1051,9		946,7		1262,2	
		20,4		30,5		40,7		27,1		40,7		54,3		33,9		50,9		67,9		61,1		81,4	
		59,3		83,7		108,1		75,3		119,3		151,8		91,4		143,5		183,9		167,6		216,1	
		632		698		757		836		925		1003		1027		1135		1235		1349		1466	

XAL Ø 900 - 1000

Raffreddatori di liquido
Dry coolers



152 - 1285 kW



Modello	Model	XAL9K (2,1 mm)	2922B		3922B		2923A		3923A	
Potenza	Capacity	<input type="checkbox"/> kW (ΔT 15K) Glycol 34%	366	303	408	326	552	457	616	494
Fluido refrigerante		m ³ /h Portata Flowrate	68,5	56,6	76,2	61	103,3	85,5	115,2	92,2
Refrigerant fluid		kPa Perdita di carico Pressure drop	68	48	67	44	33	23	35	23
Portata d'aria	Air quantity	m ³ /h	123200	90800	117600	86400	184800	136200	176400	129600
Assorbimento motori		W	18360	11160	18360	11160	27540	16740	27540	16740
Motor power consumption		A	32	18,4	32	18,4	48	27,6	48	27,6
Livello pressione sonora	Sound pressure level	dB (A) (Total)	66	57	66	57	68	59	68	59
Attacchi	Connections	Ø"	4		4		2x 4		2x 4	
Modello	Model	XAL9N (2,1 mm)	5922B		6922B		5923A		6923A	
Potenza	Capacity	<input type="checkbox"/> kW (ΔT 15K) Glycol 34%	318	266	345	278	480	402	522	410
Fluido refrigerante		m ³ /h Portata Flowrate	59,5	49,8	64,5	52	89,8	75,2	97,6	76,5
Refrigerant fluid		kPa Perdita di carico Pressure drop	52	38	49	32	26	18	25	16
Portata d'aria	Air quantity	m ³ /h	98000	75200	93200	70000	147000	112800	139800	105000
Assorbimento motori		W	9200	6240	9480	6320	13800	9360	14220	9480
Motor power consumption		A	20,4	11,6	20,4	11,6	30,6	17,4	30,6	17,4
Livello pressione sonora	Sound pressure level	dB (A) (Total)	58	50	58	50	60	52	60	52
Attacchi	Connections	Ø"	4		4		2x 4		2x 4	
Modello	Model	XAL9X (2,1 mm)	7922B	8922B	9922F	7923A	8923E	9923E		
Potenza	Capacity	<input type="checkbox"/> kW (ΔT 15K) Glycol 34%	208	175	239	190	243	185	306	258
Fluido refrigerante		m ³ /h Portata Flowrate	38,9	32,7	44,6	35,5	45,4	34,6	57,1	48,2
Refrigerant fluid		kPa Perdita di carico Pressure drop	62	45	31	20	48	29	30	22
Portata d'aria	Air quantity	m ³ /h	68000	52000	64000	48000	60400	44400	102000	78000
Assorbimento motori		W	3280	2080	3280	2080	3400	2120	4920	3120
Motor power consumption		A	8,8	4,6	8,8	4,6	8,8	4,6	13,2	6,9
Livello pressione sonora	Sound pressure level	dB (A) (Total)	47	40	47	40	47	40	49	42
Attacchi	Connections	Ø"	2 1/2		4		4		2x 2 1/2	2x 4
Modello	Model	XAL9U (2,1 mm)	1922B	4922B	1923A		4923E			
Potenza	Capacity	<input type="checkbox"/> kW (ΔT 15K) Glycol 34%	152	127	157	128	226	187	240	194
Fluido refrigerante		m ³ /h Portata Flowrate	28,5	23,8	29,4	23,9	42,2	34,9	44,8	36,3
Refrigerant fluid		kPa Perdita di carico Pressure drop	34	24	14	9	17	12	30	21
Portata d'aria	Air quantity	m ³ /h	42400	33600	40000	31200	63600	50400	60000	46800
Assorbimento motori		W	1080	664	1080	684	1620	996	1620	1026
Motor power consumption		A	3,2	1,6	3,2	1,6	4,8	2,4	4,8	2,4
Livello pressione sonora	Sound pressure level	dB (A) (Total)	36	30	36	30	38	32	38	32
Attacchi	Connections	Ø"	2 1/2"		4"		2x 2 1/2"		2x 4"	

DATI COMUNI / COMMON DATA

Elettroventilatori		Ø 900 mm x n°	4 88	4 88	4 88	6 888	6 888	6 888		
Fans		Collegamento Connection	△ △	△ △	△ △	△ △	△ △	△ △	△ △	△ △
Superficie esterna	TURBOCOIL	External surface	210,4	315,6	420,8	420,8	631,2	841,4		
Superficie interna		Internal surface	13,6	20,4	27,1	27,1	40,7	54,3		
Volume circuito		Circuit volume	86,4	142,3	175	118,5	190,5	239,3		
Peso		Weight	780	873	958	1112	1265	1392		

Modello	Model	XAL10N (2,1 mm)	2722B		3722B		2723A		3723A	
Potenza	Capacity	<input type="checkbox"/> kW (ΔT 15K) Glycol 34%	340	298	372	316	512	450	562	473
Fluido refrigerante		m ³ /h Portata Flowrate	63,5	55,7	69,5	59	95,8	84,2	105	88,5
Refrigerant fluid		kPa Perdita di carico Pressure drop	59	46	56	41	29	23	29	21
Portata d'aria	Air quantity	m ³ /h	108800	88800	102800	82400	163200	133200	154200	123600
Assorbimento motori		W	9560	7280	9800	7280	14340	10920	14700	10920
Motor power consumption		A	22,8	13,2	22,8	13,2	34,2	19,8	34,2	19,8
Livello pressione sonora	Sound pressure level	dB (A) (Total)	58	53	58	53	60	55	60	55
Attacchi	Connections	Ø"	4		4		2x 4		2x 4	

DATI COMUNI / COMMON DATA

Elettroventilatori		Ø 1000 mm x n°	4 88	4 88	4 88	6 888	6 888	6 888		
Fans		Collegamento Connection	△ △	△ △	△ △	△ △	△ △	△ △	△ △	△ △
Superficie esterna	TURBOCOIL	External surface	210,4	315,6	420,8	420,8	631,2	841,4		
Superficie interna		Internal surface	13,6	20,4	27,1	27,1	40,7	54,3		
Volume circuito		Circuit volume	86,4	142,3	175	118,5	190,5	239,3		
Peso		Weight	780	873	958	1112	1265	1392		



- Potenza con tubi puliti
- Capacity with clean tubes

Attacchi lati opposti: **A-F-N**
 Connections opposite sides: **A-F-N**



		2924A		3924A				2925N		3925N		2926N		3926N			
		754	623	839	671			955	788	1062	848	1158	954	1285	1026		
		140,9	116,4	156,9	125,4			178,7	147,4	198,6	158,6	216,5	178,4	240,3	191,7		
		70	49	69	45			97	68	80	53	158	111	129	85		
		246400	181600	235200	172800			308000	227000	294000	216000	369600	272400	352800	259200		
		36720	22320	36720	22320			45900	27900	45900	27900	55080	33480	55080	33480		
		64	36,8	64	36,8			80	46	80	46	96	55,2	96	55,2		
		69	60	69	60			70	61	70	61	71	62	71	62		
		2x 4		2x 4				3x 4		3x 4		3x 4		3x 4			
		5924A		6924A				5925N		6925N		5926N		6926N			
		655	548	710	556			829	693	898	702	1004	839	1086	849		
		122,4	102,4	132,8	104			155	129,6	167,9	131,4	187,7	156,9	203	158,6		
		54	38	50	32			75	54	59	37	122	88	95	60		
		196000	150400	186400	140000			245000	188000	233000	175000	294000	225600	279600	210000		
		18400	12480	18960	12640			23000	15600	23700	15800	27600	18720	28440	18960		
		40,8	23,2	40,8	23,2			51	29	51	29	61,2	34,8	61,2	34,8		
		61	53	61	53			62	54	62	54	63	55	63	55		
		2x 4		2x 4				3x 4		3x 4		3x 4		3x 4			
		7924A		8924A		9924A		7925N		8925A		9925A		8926A		9926A	
		421	351	483	382	486	365	534	447	608	483	610	459	740	588	745	554
		78,5	65,5	90,1	71,3	90,8	68,3	99,5	83,4	113,4	90,1	114	85,8	137,9	109,6	139,2	103,6
		62	44	30	19	24	14	69	50	53	34	41	24	85	56	66	38
		136000	104000	128000	96000	120800	88800	170000	130000	160000	120000	151000	111000	192000	144000	181200	133200
		6560	4160	6560	4160	6800	4240	8200	5200	8200	5200	8500	5300	9840	6240	10200	6360
		17,6	9,2	17,6	9,2	17,6	9,2	22	11,5	22	11,5	22	11,5	26,4	13,8	26,4	13,8
		50	43	50	43	50	43	51	44	51	44	51	44	52	45	52	45
		2x 2 1/2		2x 4		2x 4		2x 4		2x 4		2x 4		2x 4		2x 4	
		1924A		4924A				1925N		4925A				4926A			
		313	254	315	255			396	322	397	322			479	388		
		58,5	47,4	58,8	47,8			74	60,3	74,2	60,2			89,6	72,6		
		35	24	13	9			41	28	24	16			38	26		
		84800	67200	80000	62400			106000	84000	100000	78000			120000	93600		
		2160	1328	2160	1368			2700	1660	2700	1710			3240	2052		
		6,4	3,2	6,4	3,2			8	4	8	4			9,6	4,8		
		39	33	39	33			40	34	40	34			41	35		
		2x 2 1/2"		2x 4"				2x 4"		2x 4"				2x 4"			
		8	8888	8	8888	8	8888	10	88888	10	88888	10	88888	12	888888	12	888888
		△	△	△	△	△	△	△	△	△	△	△	△	△	△	△	△
		631,2		946,6		1262,2		841,4		1262,2		1683		1577,8		2103,8	
		40,7		61,1		81,4		54,3		81,4		108,6		101,8		135,7	
		150,7		238,7		303,5		206		286,9		367,8		335,1		432,1	
		1451		1641		1808		1802		2035		2248		2441		2696	

		2724A		3724A				2725N		3725N		2726N		3726N			
		698	614	764	643			885	777	967	813	1072	941	1170	983		
		130,5	114,7	142,8	120,2			165,4	145,2	180,8	151,9	200,4	175,8	218,7	183,7		
		60	47	58	42			84	66	68	49	137	108	109	79		
		217600	177600	205600	164800			272000	222000	257000	206000	326400	266400	308400	247200		
		19120	14560	19600	14560			23900	18200	24500	18200	28680	21840	29400	21840		
		45,6	26,4	45,6	26,4			57	33	57	33	68,4	39,6	68,4	39,6		
		61	56	61	56			62	57	62	57	63	58	63	58		
		2x 4		2x 4				3x 4		3x 4		3x 4		3x 4			
		8	8888	8	8888	8	8888	10	88888	10	88888	10	88888	12	888888	12	888888
		△	△	△	△	△	△	△	△	△	△	△	△	△	△	△	△
		631,2		946,6		1262,2		841,4		1262,2		1683		1577,8		2103,8	
		40,7		61,1		81,4		54,3		81,4		108,6		101,8		135,7	
		150,7		238,7		303,5		206		286,9		367,8		335,1		432,1	
		1451		1641		1808		1802		2035		2248		2441		2696	

41 - 592 kW

New



Modello	Model	EHL95F	1118C	1119C	1128B	1129E	1138A
Potenza	Capacity	<input type="checkbox"/> kW (ΔT 15K) Glycol 34%	85	93	172	188	252
Fluido refrigerante		m ³ /h Portata Flowrate	16,5	18	33,7	36,8	49,4
Refrigerant fluid		kPa Perdita di carico Pressure drop	77	62	65	44	35
Portata d'aria	Air quantity	m ³ /h	27700	26000	55400	52000	83100
Assorbimento motori		W	2730	2840	5460	5680	8190
Motor power consumption	400V - 3ph - 50Hz	A	4,6	4,6	9,2	9,2	13,8
Livello pressione sonora	Sound pressure level	dB (A) (Total)	55	55	57	57	59
Attacchi	Connections	Ø"	2	2	2 ½	4	4
Modello	Model	EHL95N	7115C	8116C	8125B	8126E	8135A
Potenza	Capacity	<input type="checkbox"/> kW (ΔT 15K) Glycol 34%	80	87	162	175	237
Fluido refrigerante		m ³ /h Portata Flowrate	15,5	16,9	31,7	34,3	46,4
Refrigerant fluid		kPa Perdita di carico Pressure drop	69	55	59	39	31
Portata d'aria	Air quantity	m ³ /h	25100	23500	50200	47000	75300
Assorbimento motori		W	2110	2200	4220	4400	6330
Motor power consumption	400V - 3ph - 50Hz	A	3,5	3,5	7	7	10,5
Livello pressione sonora	Sound pressure level	dB (A) (Total)	52	52	54	54	56
Attacchi	Connections	Ø"	2	2	2 ½	4	4
DATI COMUNI / COMMON DATA							
Elettroventilatori	Fans	Ø 950 mm x n°	1 o	1 o	2 oo	2 oo	3 ooo
Superficie esterna	External surface	m ²	151,5	202,0	303,0	404,0	454,5
Superficie interna	TURBOCOIL Internal surface	m ²	8,4	11,2	16,8	22,5	25,3
Volume circuito	Circuit volume	dm ³	25	32	54	74	80
Peso	Weight	kg	229,0	267,0	433,0	467,0	607,0

Modello	Model	EHL95X	3116C	3117C	3118D	3126E	3127B	3128B	3136A	3137B
Potenza	Capacity	<input type="checkbox"/> kW (ΔT 15K) Glycol 34%	51	56	59	102	113	116	151	174
Fluido refrigerante		m ³ /h Portata Flowrate	9,9	10,9	11,4	19,8	21,9	22,5	29,6	34,1
Refrigerant fluid		kPa Perdita di carico Pressure drop	64	36	66	49	31	21	27	91
Portata d'aria	Air quantity	m ³ /h	16500	15000	14800	33000	30000	29600	49500	45000
Assorbimento motori		W	550	590	590	1100	1180	1180	1650	1770
Motor power consumption	400V - 3ph - 50Hz	A	0,9	0,9	0,9	1,8	1,8	1,8	2,7	2,7
Livello pressione sonora	Sound pressure level	dB (A) (Total)	39	39	39	41	41	41	43	43
Attacchi	Connections	Ø"	1 ½	2	2	2 ½	2 ½	2 ½	2 ½	2 ½
Modello	Model	EHL95U	5116C	5117D		5126E	5127F		5136E	5137B
Potenza	Capacity	<input type="checkbox"/> kW (ΔT 15K) Glycol 34%	41	44		82	88		126	131
Fluido refrigerante		m ³ /h Portata Flowrate	8	8,5		15,9	17,1		24,4	25,4
Refrigerant fluid		kPa Perdita di carico Pressure drop	43	60		33	53		98	55
Portata d'aria	Air quantity	m ³ /h	11800	10600		23600	21200		35400	31800
Assorbimento motori		W	230	240		460	480		690	720
Motor power consumption	400V - 3ph - 50Hz	A	0,5	0,5		1	1		1,5	1,5
Livello pressione sonora	Sound pressure level	dB (A) (Total)	32	32		34	34		36	36
Attacchi	Connections	Ø"	1 ½	2		2 ½	2 ½		2 ½	2 ½
DATI COMUNI / COMMON DATA										
Elettroventilatori	Fans	Ø 950 mm x n°	1 o	1 o	1 o	2 oo	2 oo	2 oo	3 ooo	3 ooo
Superficie esterna	External surface	m ²	101,0	151,5	174,9	202,0	303,0	349,8	303,0	454,5
Superficie interna	TURBOCOIL Internal surface	m ²	5,6	8,4	11,2	11,2	16,8	22,5	16,8	25,3
Volume circuito	Circuit volume	dm ³	16	25	32	40	54	67	54	74
Peso	Weight	kg	229,0	250,0	267,0	#N/A	433,0	467,0	549,0	607,0



- Potenza con tubi puliti Attacchi lati opposti: **A-F-N**
- Capacity with clean tubes Connections opposite sides: **A-F-N**

	1139A		1148A	1149A		1158N	1159N		1168N	1169N
	276		347	379		444	484		543	592
	54,1		68,6	75		88,7	96,7		109,5	119,4
	32		75	67		108	79		179	131
	78000		110800	104000		138500	130000		166200	156000
	8520		10920	11360		13650	14200		16380	17040
	13,8		18,4	18,4		23	23		27,6	27,6
	59		59	59		60	60		61	61
	4		4	4		2x4	2x4		2x4	2x4
	8136A		8145A	8146A		8155N	8156N		8165N	8166N
	257		327	353		418	451		512	551
	50,3		64,7	69,8		83,5	90,1		103,2	111,1
	28		67	58		97	69		161	115
	70500		100400	94000		125500	117500		150600	141000
	6600		8440	8800		10550	11000		12660	13200
	10,5		14	14		17,5	17,5		21	21
	56		56	56		57	57		58	58
	4		4	4		2x4	2x4		2x4	2x4
	3 000		4 0000	4 0000		5 00000	5 00000		6 000000	6 000000
	606,0		606,0	808,0		757,5	1010,0		909,0	1212,0
	33,7		33,7	44,9		42,1	56,1		50,5	67,4
	100		100	127		120	154		140	180
	658,0		804,0	873,0		987,0	1074,0		1173,0	1276,0

	3138B	3146A	3147A	3148A	3156N	3157A	3158A		3167A	3168A
	178	206	228	233	263	291	297		355	363
	34,9	40,4	44,7	45,6	52	57,6	58,8		70,9	72,5
	61	58	35	27	87	63	48		102	76
	44400	66000	60000	59200	82500	75000	74000		90000	88800
	1770	2200	2360	2360	2750	2950	2950		3540	3540
	2,7	3,6	3,6	3,6	4,5	4,5	4,5		5,4	5,4
	43	43	43	43	44	44	44		45	45
	2 ½	2 ½	4	4	2x2 ½	4	4		4	4
		5146A	5147B		5156A	5157A		5166A	5167A	
		166	178		212	222		256	268	
		32,5	34,9		41,9	43,9		50,6	53	
		39	119		71	38		115	61	
		47200	42400		59000	53000		70800	63600	
		920	960		1150	1200		1380	1440	
		2	2		2,5	2,5		3	3	
		36	36		37	37		38	38	
		2 ½	2 ½		2 ½	4		2 ½	4	
	3 000	4 0000	4 0000	4 0000	5 00000	5 00000	5 00000	6 000000	6 000000	6 000000
	524,7	404,0	606,0	699,6	505,0	757,5	874,5	606,0	909,0	1049,4
	33,7	22,5	33,7	44,9	28,1	42,1	56,1	33,7	50,5	67,4
	94	67	100	127	80	120	154	94	140	180
	658,0	727,0	804,0	873,0	893,0	987,0	1074,0	1057,0	1173,0	1276,0

166 - 1210 kW

New



Modello	Model	EHL95F	2223B	2224B	2233A	2234A	2243A
Potenza	Capacity	□ kW (ΔT 15K) Glycol 34%	349	380	521	569	717
Fluido refrigerante		m ³ /h Portata Flowrate	69	75,2	105	114,7	145,9
Refrigerant fluid		kPa Perdita di carico Pressure drop	79	69	36	33	78
Portata d'aria	Air quantity	m ³ /h	110800	104000	166200	156000	221600
Assorbimento motori		W	10920	11360	16380	17040	21840
Motor power consumption	400V - 3ph - 50Hz	A	18,4	18,4	27,6	27,6	36,8
Livello pressione sonora	Sound pressure level	dB (A) (Total)	59	59	61	61	62
Attacchi	Connections	Ø"	4	4	2x4	2x4	2x4
Modello	Model	EHL95N	9221B	9222B	9231A	9232A	9241A
Potenza	Capacity	□ kW (ΔT 15K) Glycol 34%	329	355	491	531	676
Fluido refrigerante		m ³ /h Portata Flowrate	65,1	70,2	99	107,1	137,6
Refrigerant fluid		kPa Perdita di carico Pressure drop	71	61	33	29	70
Portata d'aria	Air quantity	m ³ /h	100400	94000	150600	141000	200800
Assorbimento motori		W	8440	8800	12660	13200	16880
Motor power consumption	400V - 3ph - 50Hz	A	14	14	21	21	28
Livello pressione sonora	Sound pressure level	dB (A) (Total)	56	56	58	58	59
Attacchi	Connections	Ø"	4	4	2x4	2x4	2x4
DATI COMUNI / COMMON DATA							
Elettroventilatori	Fans	Ø 950 mm x n°	4 00	4 00	6 000	6 000	8 0000
Superficie esterna	External surface	m ²	606,0	808,0	909,0	1212,0	1212,0
Superficie interna	Internal surface	m ²	33,7	44,9	50,5	67,4	67,4
Volume circuito	Circuit volume	dm ³	121	147	161	201	201
Peso	Weight	kg	759,0	834,0	1099,0	1211,0	1426,0

Modello	Model	EHL95X	5226E	5227B	5228F	5236A	5237E	5238E	5246A	5247A
Potenza	Capacity	□ kW (ΔT 15K) Glycol 34%	207	229	238	309	357	365	426	471
Fluido refrigerante		m ³ /h Portata Flowrate	40,6	44,9	46,6	61,7	71,3	72,9	85,9	95
Refrigerant fluid		kPa Perdita di carico Pressure drop	50	36	63	28	88	57	61	36
Portata d'aria	Air quantity	m ³ /h	66000	60000	59200	99000	90000	88800	132000	120000
Assorbimento motori		W	2200	2360	2360	3300	3540	3540	4400	4720
Motor power consumption	400V - 3ph - 50Hz	A	3,6	3,6	3,6	5,4	5,4	5,4	7,2	7,2
Livello pressione sonora	Sound pressure level	dB (A) (Total)	43	43	43	45	45	45	46	46
Attacchi	Connections	Ø"	2x2 1/2	4	4	2x2 1/2	2x4	2x4	2x2 1/2	2x4
Modello	Model	EHL95U	8226E	8227F	8236E	8237B	8246A	8247B		
Potenza	Capacity	□ kW (ΔT 15K) Glycol 34%	166	178	257	269	339	365		
Fluido refrigerante		m ³ /h Portata Flowrate	32,5	34,9	50,8	53,2	67,7	72,9		
Refrigerant fluid		kPa Perdita di carico Pressure drop	33	57	101	64	40	136		
Portata d'aria	Air quantity	m ³ /h	47200	42400	70800	63600	94400	84800		
Assorbimento motori		W	920	960	1380	1440	1840	1920		
Motor power consumption	400V - 3ph - 50Hz	A	2	2	3	3	4	4		
Livello pressione sonora	Sound pressure level	dB (A) (Total)	36	36	38	38	39	39		
Attacchi	Connections	Ø"	2x2 1/2	4	2x2 1/2	4	2x2 1/2	4		
DATI COMUNI / COMMON DATA										
Elettroventilatori	Fans	Ø 950 mm x n°	4 00	4 00	4 00	6 000	6 000	6 000	8 0000	8 0000
Superficie esterna	External surface	m ²	404,0	606,0	699,6	606,0	909,0	1049,4	808,0	1212,0
Superficie interna	Internal surface	m ²	22,5	33,7	44,9	33,7	50,5	67,4	44,9	67,4
Volume circuito	Circuit volume	dm ³	81	121	147	108	161	201	134	201
Peso	Weight	kg	677,0	759,0	834,0	966,0	1099,0	1211,0	1260,0	1426,0



- Potenza con tubi puliti
- Capacity with clean tubes

Attacchi lati opposti: **A-F-N**
 Connections opposite sides: **A-F-N**

	2244A		2253N	2254N		2263N	2264N
	783		918	1000		1112	1210
	159,4		188,6	205,4		228,4	248,6
	69		118	91		194	147
	208000		277000	260000		332400	312000
	22720		27300	28400		32760	34080
	36,8		46	46		55,2	55,2
	62		63	63		64	64
	2x4		3x4	3x4		3x4	3x4
	9242A		9251N	9252N		9261N	9262N
	730		865	932		1048	1127
	148,6		177,7	191,5		215,3	231,5
	60		106	80		174	129
	188000		251000	235000		301200	282000
	17600		21100	22000		25320	26400
	28		35	35		42	42
	59		60	60		61	61
	2x4		3x4	3x4		3x4	3x4
	8		10	10		12	12
	1616,0		1515,0	2020,0		1818,0	2424,0
	89,9		84,2	112,3		101,1	134,8
	254		241	308		281	361
	1572,0		1768,0	1955,0		2121,0	2345,0

	5248A	5256N	5257A	5258A		5267A	5268A
	482	544	602	615		735	750
	97,2	110,7	122,5	125,2		151	154,1
	28	96	65	49		106	79
	118400	165000	150000	148000		180000	177600
	4720	5500	5900	5900		7080	7080
	7,2	9	9	9		10,8	10,8
	46	47	47	47		48	48
	2x4	2x4	2x4	2x4		2x4	2x4
		8256A	8257A		8266N	8267A	
		434	454		530	549	
		87,5	91,5		107,9	110,7	
		73	39		106	63	
		118000	106000		141600	127200	
		2300	2400		2760	2880	
		5	5		6	6	
		40	40		41	41	
		2x2 ½	2x4		2x4	2x4	
	8	10	10	10	12	12	12
	1399,2	1010,0	1515,0	1749,0	1212,0	1818,0	2098,8
	89,9	56,2	84,2	112,3	67,4	101,1	134,8
	254	174	241	308	201	281	361
	1572,0	1565,0	1768,0	1955,0	1887,0	2121,0	2345,0

EHL Ø 900 · EAL Ø 800-900

Raffreddatori di liquido
Dry coolers



35 - 498 kW



Modello	Model	EHL90F (2,1 mm)	340C	342C	344B	346E	348A			
Potenza	Capacity	□ kW (ΔT 15K) Glycol 34%	77	84	154	169	227			
Fluido refrigerante	m ³ /h Portata Flowrate	14,4	15,7	28,7	31,6	42,4				
Refrigerant fluid	kPa Perdita di carico Pressure drop	60	49	58	35	28				
Portata d'aria	Air quantity	26500	24500	53000	49000	79500				
Assorbimento motori	W	3250	3250	6500	6500	9750				
Motor power consumption	A	6,0	6,0	12,0	12,0	18,0				
Livello pressione sonora	Sound pressure level	58	58	60	60	62				
Attacchi	Connections	Ø"	2"	2"	2 1/2"	4"				
Modello	Model	EAL9N (2,1 mm)	6111C	6112C	6121B	6122E	6131A			
Potenza	Capacity	□ kW (ΔT 15K) Glycol 34%	70	76	140	153	206			
Fluido refrigerante	m ³ /h Portata Flowrate	13,1	14,3	26,3	21,9	28,5				
Refrigerant fluid	kPa Perdita di carico Pressure drop	50	40	47	34	28				
Portata d'aria	Air quantity	23500	22000	47000	35200	44000				
Assorbimento motori	W	2400	2400	4800	3180	4800				
Motor power consumption	A	5,2	5,2	10,4	6	10,4				
Livello pressione sonora	Sound pressure level	54	54	56	49	56				
Attacchi	Connections	Ø"	2"	2"	2 1/2"	4"				
Modello	Model	EAL8S (2,1 mm)	7111C	7112C	7121B	7122E	7131A			
Potenza	Capacity	□ kW (ΔT 15K) Glycol 34%	61	66	122	103	178			
Fluido refrigerante	m ³ /h Portata Flowrate	11,4	9,6	22,7	19,3	24,6				
Refrigerant fluid	kPa Perdita di carico Pressure drop	39	28	37	27	22				
Portata d'aria	Air quantity	19300	18200	38600	29000	36400				
Assorbimento motori	W	1700	1700	3400	2300	3400				
Motor power consumption	A	3,7	3,7	7,4	4,2	7,4				
Livello pressione sonora	Sound pressure level	48	48	50	43	50				
Attacchi	Connections	Ø"	2"	2"	2 1/2"	4"				
Modello	Model	EAL9X (2,1 mm)	1110C	1111C	1112D	1120E	1121B	1122B	1130A	1131B
Potenza	Capacity	□ kW (ΔT 15K) Glycol 34%	46	53	55	93	106	108	136	163
Fluido refrigerante	m ³ /h Portata Flowrate	8,5	9,9	10,3	17,4	19,8	15,9	20,2	25,4	30,4
Refrigerant fluid	kPa Perdita di carico Pressure drop	50	30	56	33	29	19	21	27	34
Portata d'aria	Air quantity	16400	15200	14100	32800	30400	22200	28200	49200	45600
Assorbimento motori	W	860	860	860	1720	1720	1060	1720	2580	2580
Motor power consumption	A	2,2	2,2	2,2	4,4	4,4	2,3	4,4	6,6	6,6
Livello pressione sonora	Sound pressure level	43	43	43	45	45	38	45	47	47
Attacchi	Connections	Ø"	1 1/2"	2"	2"	2 1/2"	2 1/2"	2 1/2"	2 1/2"	2 1/2"
Modello	Model	EAL8T (2,1 mm)	8110C	8111C	8112D	8120B	8121B	8122B	8130A	8131B
Potenza	Capacity	□ kW (ΔT 15K) Glycol 34%	43	49	53	86	100	104	127	152
Fluido refrigerante	m ³ /h Portata Flowrate	8,1	9,2	9,9	16,1	18,6	15,2	19,5	23,7	28,5
Refrigerant fluid	kPa Perdita di carico Pressure drop	44	26	51	33	25	17	19	23	28
Portata d'aria	Air quantity	15200	14200	13000	30400	28400	21800	26000	45600	42600
Assorbimento motori	W	820	820	820	1640	1640	1040	1640	2460	2460
Motor power consumption	A	2,3	2,3	2,3	4,6	4,6	2,2	4,6	6,9	6,9
Livello pressione sonora	Sound pressure level	41	41	41	43	43	38	43	45	45
Attacchi	Connections	Ø"	1 1/2"	2"	2"	2 1/2"	2 1/2"	2 1/2"	2 1/2"	2 1/2"
Modello	Model	EAL9U (2,1 mm)	5110C	5111D	5120E	5121F	5130E	5131B		
Potenza	Capacity	□ kW (ΔT 15K) Glycol 34%	34	37	69	75	106	113		
Fluido refrigerante	m ³ /h Portata Flowrate	6,4	7	12,9	11	19,8	16,7	21,2		
Refrigerant fluid	kPa Perdita di carico Pressure drop	29	21	23	17	39	26	42		
Portata d'aria	Air quantity	10200	9400	20400	16000	30600	24000	28200		
Assorbimento motori	W	275	275	550	350	825	525	825		
Motor power consumption	A	0,8	0,8	1,6	0,8	2,4	1,2	2,4		
Livello pressione sonora	Sound pressure level	32	32	34	28	36	30	36		
Attacchi	Connections	Ø"	1 1/2"	2"	2 1/2"	2 1/2"	2 1/2"	2 1/2"		
DATI COMUNI / COMMON DATA										
Elettroventilatori	Ø 800-900 mm x n°		1 o	1 o	1 o	2 oo	2 oo	2 oo	3 ooo	3 ooo
Fans	Collegamento	Connection	△	△	△	△	△	△	△	△
Superficie esterna	External surface	m ²	87,5	131,3	175,1	175	262,6	350,2	262,5	393,9
Superficie interna	Internal surface	m ²	5,6	8,4	11,2	11,2	16,8	22,4	16,8	25,2
Volume circuito	Circuit volume	dm ³	16	25	32	36	49	63	49	70
Peso	Weight	kg	218	238	254	367	412	445	523	578

Potenza con tubi puliti
 Capacity with clean tubes

Attacchi lati opposti: **A-F-N**
 Connections opposite sides: **A-F-N**



350A				352A		354A				356N		358N				360N		362N			
250	193			315	255	345	265			399	325	436	340			485	398	529	413		
46,7	36,1			58,7	47,5	64,4	49,5			74,4	60,6	81,3	63,4			90,5	74,1	98,7	77		
26	16			60	41	54	33			86	59	64	40			143	100	105	67		
73500	51300			106000	76000	98000	68400			132500	95000	122500	85500			159000	114000	147000	102600		
9750	6000			13000	8000	13000	8000			16250	10000	16250	10000			19500	12000	19500	12000		
18,0	10,5			24,0	14,0	24,0	14,0			30,0	17,5	30,0	17,5			36,0	21,0	36,0	21		
62	55			62	55	62	55			63	56	63	56			64	57	64	57		
4"				4"		4"				2 x 4"		2 x 4"				2 x 4"		2 x 4"			
6132A				6141A		6142A				6151N		6152N				6161N		6162N			
224	179			281	234	305	244			359	299	390	311			435	362	472	376		
41,9	33,6			52,4	43,8	57,1	45,5			67,2	56,0	72,9	58,1			81,3	67,8	88,3	70,3		
20	13			47	34	42	27			69	49	50	33			114	82	82	54		
66000	48000			94000	70400	88000	64000			117500	88000	110000	80000			141000	105600	132000	96000		
7200	4770			9600	6360	9600	6360			12000	7950	12000	7950			14400	9540	14400	9540		
15,6	9			20,8	12	20,8	12			26	15	26	15			31,2	18	31,2	18		
58	51			58	51	58	51			59	52	59	52			60	53	60	53		
4"				4"		4"				2 x 4"		2 x 4"				2 x 4"		2 x 4"			
7132E				7141A		7142A				7151N		7152N				7161N		7162N			
201	164			243	206	263	215			308	263	332	274			373	318	402	331		
37,6	30,6			45,5	38,5	49,3	40,2			57,6	49,2	62,2	51,2			69,8	59,5	75,1	61,8		
65	44			37	27	32	21			53	39	38	26			88	65	62	43		
54600	41400			77200	58000	72800	55200			96500	72500	91000	69000			115800	87000	109200	82800		
5100	3450			6800	4600	6800	4600			8500	5750	8500	5750			10200	6900	10200	6900		
11,1	6,3			14,8	8,4	14,8	8,4			18,5	10,5	18,5	10,5			22,2	12,6	22,2	12,6		
52	45			52	45	52	45			53	46	53	46			54	47	54	47		
4"				4"		4"				2 x 4"		2 x 4"				2 x 4"		2 x 4"			
1132B		1140A		1141A		1142A		1150N		1151A		1152A				1161A		1162A			
165	123	188	159	216	172	220	165	242	203	278	220	282	210			335	270	340	255		
30,9	23	35,1	29,6	40,3	32,1	41,1	30,9	45,1	37,9	51,8	41	52,6	39,2			62,5	50,3	63,5	47,6		
60	34	58	43	30	20	23	13	76	55	55	36	41	24			89	50	65	28		
42300	30300	65600	49200	60800	44400	56400	40400	82000	61500	76000	55500	70500	50500			91200	66600	84600	60600		
2580	1590	3440	2120	3440	2120	3440	2120	4300	2650	4300	2650	4300	2650			5160	3180	5160	3180		
6,6	3,45	8,8	4,6	8,8	4,6	8,8	4,6	11	5,75	11	5,75	11	5,75			13,2	6,9	13,2	6,9		
47	40	47	40	47	40	47	40	48	41	48	41	48	41			49	42	49	42		
2 1/2"		2 1/2"		4"		4"		2 x 2 1/2"		4"		4"				4"		4"			
8132B		8140A		8141A		8142A		8150N		8151A		8152A				8161A		8162A			
159	125	173	149	199	163	208	164	222	191	254	208	265	208			308	252	320	251		
29,7	23,3	32,4	27,9	37,2	30,5	38,9	30,6	41,5	35,7	47,5	38,9	49,6	39,0			57,5	47,1	59,9	47,0		
54	34	49	37	25	17	20	13	63	48	45	31	36	23			73	42	56	26		
39000	29400	60800	47600	56800	43600	52000	39200	76000	59500	71000	54500	65000	49000			85200	65400	78000	58800		
2460	1560	3280	2080	3280	2080	3280	2080	4100	2600	4100	2600	4100	2600			4920	3120	4920	3120		
6,9	3,3	9,2	4,4	9,2	4,4	9,2	4,4	11,5	5,5	11,5	5,5	11,5	5,5			13,8	6,6	13,8	6,6		
45	40	45	40	45	40	45	40	46	41	46	41	46	41			47	42	47	42		
2 1/2"		2 1/2"		4"		4"		2 x 2 1/2"		4"		4"				4"		4"			
		5140A		5141B				5150A		5151A				5160A		5161A					
		138	117	152	121			176	149	189	150			214	180	229	180				
		25,8	21,8	28,4	22,6			33	27,9	35,4	27,9			39,9	33,7	42,7	33,8				
		32	23	90	60			57	41	26	17			90	50	42	28				
		40800	32000	37600	28800			51000	40000	47000	36000			61200	48000	56400	43200				
		1100	700	1100	700			1375	875	1375	875			1650	1050	1650	1050				
		3,2	1,6	3,2	1,6			4	2	4	2			4,8	2,4	4,8	2,4				
		36	30	36	30			37	31	37	31			38	32	38	32				
		2 1/2"		2 1/2"				2 1/2"		4"				2 1/2"		4"					
3 000		4 0000		4 0000		4 0000		5 00000		5 00000		5 00000		6 000000		6 000000		6 000000			
△	人	△	人	△	人	△	人	△	人	△	人	△	人	△	人	△	人	△	人	△	人
525,3		350		525,2		700,4		437,5		656,5		875,5		525		787,8		1050,6			
33,6		22,4		33,6		44,8		28,0		42,0		56,1		33,6		50,5		67,3			
90		63		99		126		76		119		153		89		139		179			
627		692		766		831		850		940		1023		1007		1117		1215			

139 - 996 kW



Modello	Model	EHL90F (2,1 mm)		364B	366B		368A	370A								
Potenza	Capacity	□ kW (ΔT 15K) Glycol 34%		316	255	347	266	470	380	514	400					
Fluido refrigerante		m ³ /h Portata Flowrate		58,9	47,6	64,8	49,6	87,5	70,9	95,8	74,6					
Refrigerant fluid		kPa Perdita di carico Pressure drop		63	42	56	34	29	20	27	17					
Portata d'aria	Air quantity	m ³ /h		106000	76000	98000	68400	159000	114000	147000	102200					
Assorbimento motori		W		13000	8000	13000	8000	19500	12000	19500	12000					
Motor power consumption		A		24,0	14,0	24,0	14,0	36,0	21,0	36,0	21,0					
Livello pressione sonora	Sound pressure level	dB (A) (total)		62	55	62	55	64	57	64	57					
Attacchi	Connections	Ø"		4"		4"		2 x 4"		2 x 4"						
Modello	Model	EAL9N (2,1 mm)		6221B	6222B		6231A	6232A								
Potenza	Capacity	□ kW (ΔT 15K) Glycol 34%		281	234	305	244	415	347	453	362					
Fluido refrigerante		m ³ /h Portata Flowrate		52,4	43,8	57,1	45,5	77,6	64,8	84,7	67,7					
Refrigerant fluid		kPa Perdita di carico Pressure drop		49	35	43	28	22	16	20	13					
Portata d'aria	Air quantity	m ³ /h		94000	70400	88000	64000	141000	105600	132000	96000					
Assorbimento motori		W		9600	6360	9600	6360	14400	9540	14400	9540					
Motor power consumption		A		20,8	12	20,8	12	31,2	18	31,2	18					
Livello pressione sonora	Sound pressure level	dB (A) (total)		58	51	58	51	60	53	60	53					
Attacchi	Connections	Ø"		4"		4"		2 x 4"		2 x 4"						
Modello	Model	EAL8S (2,1 mm)		7221B	7222B		7231A	7232E								
Potenza	Capacity	□ kW (ΔT 15K) Glycol 34%		243	206	263	215	356	305	402	331					
Fluido refrigerante		m ³ /h Portata Flowrate		45,5	38,5	49,2	40,2	66,5	57,1	75,1	61,8					
Refrigerant fluid		kPa Perdita di carico Pressure drop		38	28	33	22	17	13	65	45					
Portata d'aria	Air quantity	m ³ /h		77200	58000	72800	55200	115800	87000	109200	82800					
Assorbimento motori		W		6800	4600	6800	4600	10200	6900	10200	6900					
Motor power consumption		A		14,8	8,4	14,8	8,4	22,2	12,6	22,2	12,6					
Livello pressione sonora	Sound pressure level	dB (A) (total)		52	45	52	45	54	47	54	47					
Attacchi	Connections	Ø"		4"		4"		2 x 4"		2 x 4"						
Modello	Model	EAL9X (2,1 mm)	1220E	1221B	1222F	1230A	1231E	1232E	1240A							
Potenza	Capacity	□ kW (ΔT 15K) Glycol 34%	188	160	216	173	220	170	284	238	340	270	345	255	388	325
Fluido refrigerante		m ³ /h Portata Flowrate	35,1	29,9	40,3	32,3	41,2	31,8	52,9	44,3	63,3	50,3	64,4	47,7	72,2	60,5
Refrigerant fluid		kPa Perdita di carico Pressure drop	42	31	31	21	53	33	30	21	78	52	50	29	62	44
Portata d'aria	Air quantity	m ³ /h	65600	49200	60800	44400	56400	40400	98400	73800	91200	66600	84600	60600	131200	98400
Assorbimento motori		W	3440	2120	3440	2120	3440	2120	5160	3180	5160	3180	5160	3180	6880	4240
Motor power consumption		A	8,8	4,6	8,8	4,6	8,8	4,6	13,2	6,9	13,2	6,9	13,2	6,9	17,6	9,2
Livello pressione sonora	Sound pressure level	dB (A) (total)	47	40	47	40	47	40	49	42	49	42	49	42	50	43
Attacchi	Connections	Ø"	2 x 2 1/2"		4"		4"		2 x 2 1/2"		2 x 4"		2 x 4"		2 x 2 1/2"	
Modello	Model	EAL8T (2,1 mm)	8220E	8221B	8222F	8230N	8231E	8232E	8240N							
Potenza	Capacity	□ kW (ΔT 15K) Glycol 34%	173	149	199	163	212	166	254	219	305	249	320	252	350	301
Fluido refrigerante		m ³ /h Portata Flowrate	32,4	27,9	37,2	30,5	39,6	31,0	47,5	40,9	57	46,7	59,9	47,0	65,4	56,4
Refrigerant fluid		kPa Perdita di carico Pressure drop	35	27	26	18	48	31	23	18	62	43	42	27	49	37
Portata d'aria	Air quantity	m ³ /h	60800	47600	56800	43600	52000	39200	91200	71400	85200	65400	78000	58800	121600	95200
Assorbimento motori		W	3280	2080	3280	2080	3280	2080	4920	3120	4920	3120	4920	3120	6560	4160
Motor power consumption		A	9,2	4,4	9,2	4,4	9,2	4,4	13,8	6,6	13,8	6,6	13,8	6,6	18,4	8,8
Livello pressione sonora	Sound pressure level	dB (A) (total)	45	40	45	40	45	40	47	42	47	42	47	42	48	43
Attacchi	Connections	Ø"	2 x 2 1/2"		4"		4"		2 x 2 1/2"		2 x 4"		2 x 4"		2 x 2 1/2"	
Modello	Model	EAL9U (2,1 mm)	5220E	5221F		5230E	5231B		5240A							
Potenza	Capacity	□ kW (ΔT 15K) Glycol 34%	139	117	152	121			215	181	230	182			280	237
Fluido refrigerante		m ³ /h Portata Flowrate	26	21,9	28,3	22,6			40,1	33,8	43	34			52,3	44,2
Refrigerant fluid		kPa Perdita di carico Pressure drop	24	17	40	27			71	52	44	29			32	24
Portata d'aria	Air quantity	m ³ /h	40800	32000	37600	28800			61200	48000	56400	43200			81600	64000
Assorbimento motori		W	1100	700	1100	700			1650	1050	1650	1050			2200	1400
Motor power consumption		A	3,2	1,6	3,2	1,6			4,8	2,4	4,8	2,4			6,4	3,2
Livello pressione sonora	Sound pressure level	dB (A) (total)	36	30	36	30			38	32	38	32			39	33
Attacchi	Connections	Ø"	2 x 2 1/2"		4"				2 x 2 1/2"		4"				2 x 2 1/2"	
DATI COMUNI / COMMON DATA																
Elettroventilatori		Ø 800-900 mm x n°	4 ☺		4 ☺		4 ☺		6 ☺☺		6 ☺☺		6 ☺☺		8 ☺☺☺	
Fans		Collegamento Connection	△	△	△	△	△	△	△	△	△	△	△	△	△	△
Superficie esterna	TURBOCOIL External surface	m ²	350		525,2		700,4		525		787,8		1050,6		700	
Superficie interna	Internal surface	m ²	22,4		33,6		44,8		33,6		50,5		67,3		44,8	
Volume circuito	Circuit volume	dm ³	72		118		145		98		158		199		125	
Peso	Weight	kg	645		723		794		920		1047		1153		1200	



- Potenza con tubi puliti
- Capacity with clean tubes

Attacchi lati opposti: **A-F-N**
 Connections opposite sides: **A-F-N**



372A		374A				376N		378N				380N		382N	
640	520	701	542			812	660	888	688			990	800	1080	830
119,2	96,9	130,6	101			151,3	123	165,4	128,1			184,3	149	201,1	154,7
62	42	55	34			94	65	73	45			156	106	119	73
212000	152000	196000	136800			265000	190000	245000	171000			318000	228000	294000	205200
26000	16000	26000	16000			32500	20000	32500	20000			39000	24000	39000	24000
48,0	28,0	48,0	28,0			60,0	35,0	60,0	35,0			72,0	42,0	72,0	42,0
65	58	65	58			66	59	66	59			67	60	67	60
2 x 4"		2 x 4"				3 x 4"		3 x 4"				3 x 4"		3 x 4"	
6241A		6242A				6251N		6252N				6261N		6262N	
572	478	623	497			725	605	788	628			879	732	953	759
107,0	89,3	116,4	92,9			135,6	113,1	147,2	117,4			164,3	136,8	178,3	141,9
48	35	42	28			73	53	56	37			121	86	91	60
188000	140800	176000	128000			235000	176000	220000	160000			282000	211200	264000	192000
19200	12720	19200	12720			24000	15900	24000	15900			28800	19080	28800	19080
41,6	24	41,6	24			52	30	52	30			62,4	36	62,4	36
61	54	61	54			62	55	62	55			63	56	63	56
2 x 4"		2 x 4"				3 x 4"		3 x 4"				3 x 4"		3 x 4"	
7241A		7242A				7251N		7252N				7261N		7262N	
486	420	526	438			616	531	664	553			746	643	804	667
90,8	78,4	98,3	81,8			115,2	99,3	124,1	103,3			139,4	120,1	150,4	124,7
37	27	32	22			56	42	42	29			92	68	68	47
154400	116000	145600	110400			193000	145000	182000	138000			231600	174000	218400	165600
13600	9200	13600	9200			17000	11500	17000	11500			20400	13800	20400	13800
29,6	16,8	29,6	16,8			37,0	21,0	37,0	21,0			44,4	25,2	44,4	25,2
55	48	55	48			56	49	56	49			57	50	57	50
2 x 4"		2 x 4"				3 x 4"		3 x 4"				3 x 4"		3 x 4"	
1241A		1242A		1250N		1251A		1252A				1261A		1262A	
450	355	455	335	498	415	570	450	575	425			690	545	700	512
83,7	66	84,9	62,6	92,5	77,3	106	83,7	107,2	79,4			128,2	101,4	130,4	95,7
32	21	25	14	81	58	58	38	43	24			94	61	69	39
121600	88800	112800	80800	164000	123000	152000	111000	141000	101000			182400	133200	169200	121200
6880	4240	6880	4240	8600	5300	8600	5300	8600	5300			10320	6360	10320	6360
17,6	9,2	17,6	9,2	22	11,5	22	11,5	22	11,5			26,4	13,8	26,4	13,8
50	43	50	43	51	44	51	44	51	44			52	45	52	45
2 x 4"		2 x 4"		2 x 4"		2 x 4"		2 x 4"				2 x 4"		2 x 4"	
8241A		8242A		8250N		8251A		8252A				8261A		8262A	
402	330	420	331	448	385	513	421	535	417			621	509	647	503
75,1	61,7	78,5	61,8	83,8	72,0	96,0	78,6	100,1	77,9			116,1	95,0	121,0	94,0
25	18	20	13	64	49	46	32	36	23			74	51	57	36
113600	87200	104000	78400	152000	119000	142000	109000	130000	98000			170400	130800	156000	117600
6560	4160	6560	4160	8200	5200	8200	5200	8200	5200			9840	6240	9840	6240
18,4	8,8	18,4	8,8	23,0	11,0	23,0	11,0	23,0	11,0			27,6	13,2	27,6	13,2
48	43	48	43	49	44	49	44	49	44			50	45	50	45
2 x 4"		2 x 4"		2 x 4"		2 x 4"		2 x 4"				2 x 4"		2 x 4"	
5241B				5250A		5251A				5260N		5261A			
309	246			358	302	384	304			433	365	463	367		
57,7	46			66,9	56,5	71,7	56,8			81	68,4	86,6	68,6		
94	63			58	42	27	18			70	51	43	29		
75200	57600			102000	80000	94000	72000			122400	96000	112800	86400		
2200	1400			2750	1750	2750	1750			3300	2100	3300	2100		
6,4	3,2			8	4	8	4			9,6	4,8	9,6	4,8		
39	33			40	34	40	34			41	35	41	35		
4"				2 x 2 1/2"		2 x 4"				2 x 4"		2 x 4"			
8		8		10		10		10		12		12		12	
△	△	△	△	△	△	△	△	△	△	△	△	△	△	△	△
1050,4		1400,8		875		1313		1751		1050		1575,6		2101,2	
67,3		89,7		56,1		84,1		112,1		67,3		100,9		134,5	
198		252		171		238		305		198		278		359	
1358		1497		1490		1684		1862		1797		2020		2233	

SAL Ø 500

Installazione orizzontale
Horizontal installation
Installation horizontale
Aufstellung horizontal
Instalación horizontal
Горизонтальный монтаж
Instalacja pozioma

(H)

Ø 500 mm x n°	1 o	2 oo	3 ooo	4 ooo	6 ooo
A mm	1085	1895	2705	1895	2705
B mm	810	1620	2430	1620	2430

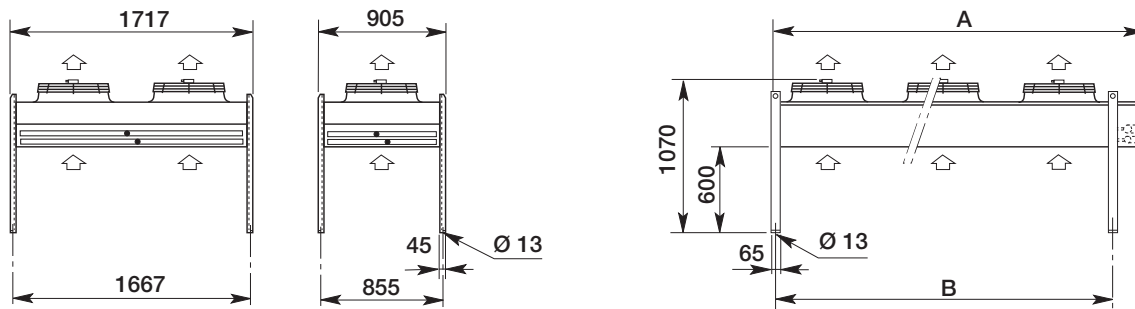

Installazione verticale
Vertical installation
Installation verticale
Aufstellung vertikal
Instalación vertical
Вертикальный монтаж
Instalacja pionowa

(V)

Ø 500 mm x n°	1 o	2 oo	3 ooo	4 ooo	6 ooo
A mm	1085	1895	2705	1895	2705
B mm	810	1620	2430	1620	2430

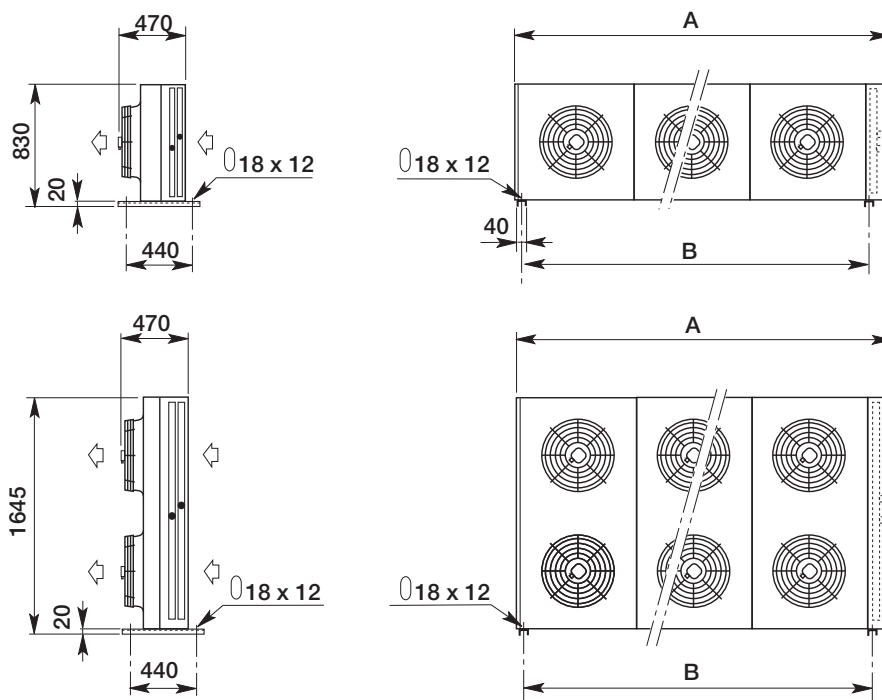

Posizione attacchi

Circuito: C, D, L, M Stesso lato

Connection position

Circuits: C, D, L, M Same side

Position des connexions

Circuits: C, D, L, M Même côté

Lage der Anschlüsse

Kreisläufe: C, D, L, M Einseitig

Posición de las conexiones

Circuitos: C, D, L, M Mismo lado

Соединительная позиция

Контур: C, D, L, M С той же стороны

Położenie przyłączy

Obieg: C, D, L, M Ta sama strona

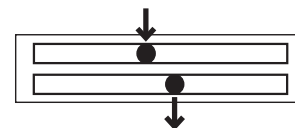

C, D, L, M

Circuiti - Circuits - Circuits - Kreisläufe
Circuitos - Контур - Obieg

SAL Ø 630

Installazione orizzontale
Horizontal installation
Installation horizontale
Aufstellung horizontal
Instalación horizontal
Горизонтальный монтаж
Instalacja pozioma

(H)	Ø 630 mm	x n°	1 o	2 oo	3 000	4 0000	5 00000	4 00	6 000	8 0000	10 00000
			A mm	1393	2393	3393	4393	5393	2393	3393	4393
B mm	1000	2000	3000	4000	5000	2000	3000	4000	5000		
C mm	—	—	—	2000	2000	—	—	2000	2000		

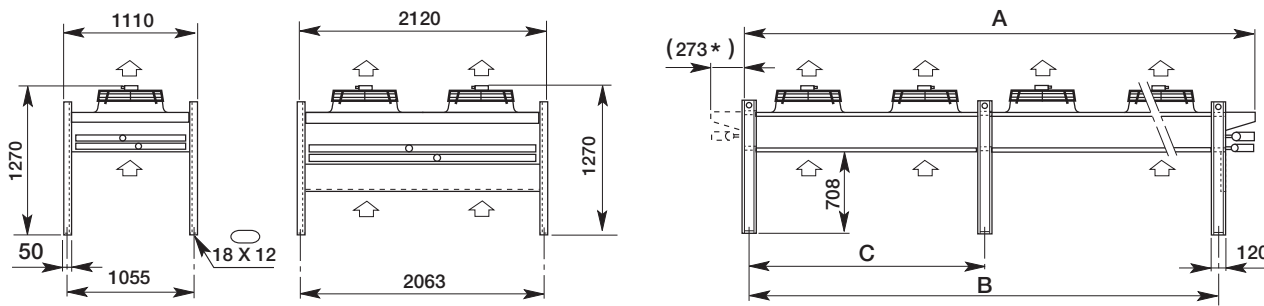

Installazione verticale
Vertical installation
Installation verticale
Aufstellung vertikal
Instalación vertical
Вертикальный монтаж
Instalacja pionowa

(M)	Ø 630 mm	x n°	1 o	2 oo	3 000	4 0000	5 00000	4 00	6 000	8 0000	10 00000
			A mm	1373	2373	3373	4373	5373	2393	3393	4393
B mm	1000	2000	3000	4000	5000	2000	3000	4000	5000		
C mm	—	—	—	2000	2000	—	—	2000	2000		

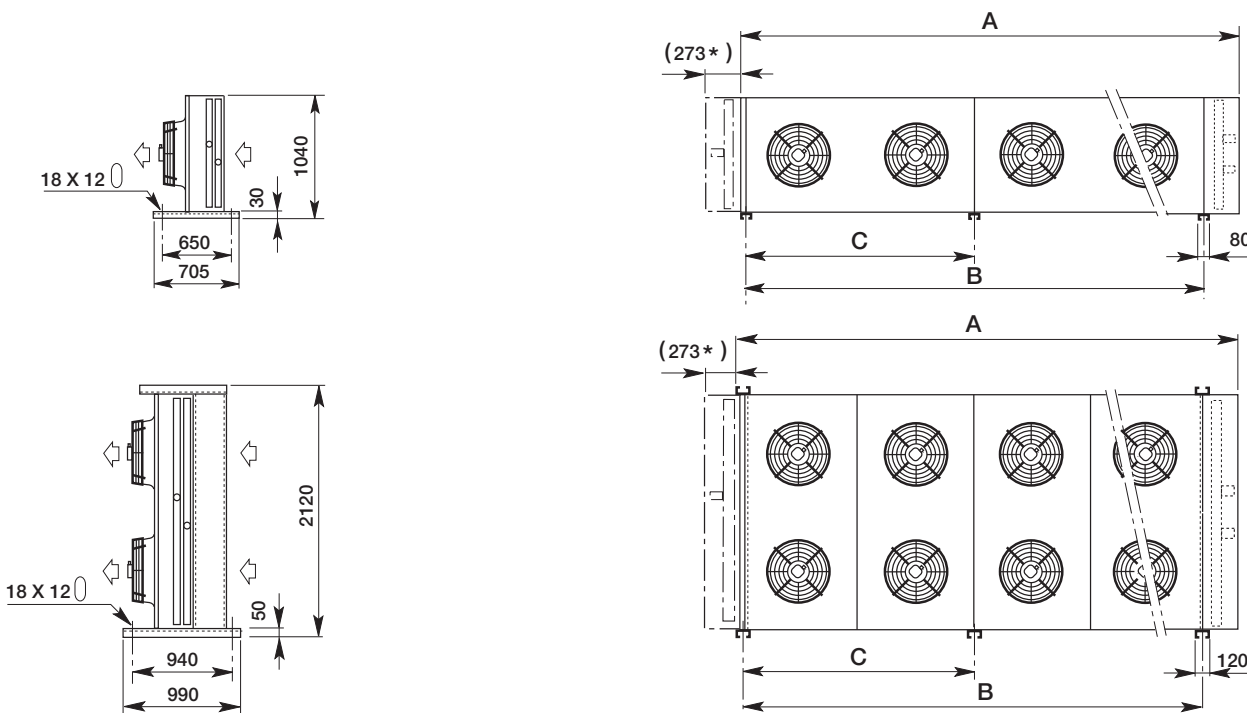

Posizione attacchi

Circuiti: A, F	Lati opposti *
Circuiti: B, C, D, L	Stesso lato

Connection position

Circuits: A, F	Opposite sides *
Circuits: B, C, D, L	Same side

Position des connexions

Circuits: A, F	Côtés opposés *
Circuits: B, C, D, L	Même côté

Lage der Anschlüsse

Kreisläufe: A, F	Zweiseitig *
Kreisläufe: B, C, D, L	Einseitig

Posición de las conexiones

Circuitos: A, F	Lados opuestos *
Circuitos: B, C, D, L	Mismo lado

Соединительная позиция

Контур: A, F	Противоположной стороне *
Контур: B, C, D, L	С той же стороны

Położenie przyłączy

Obieg: A, F	Przeciwnie strony *
Obieg: B, C, D, L	Ta sama strona

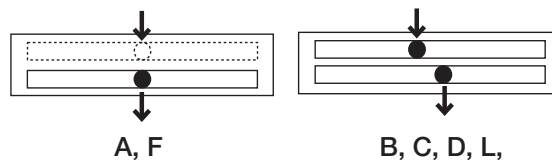

Circuiti - Circuits - Circuits - Kreisläufe
Circuitos - Контур - Obieg

SAL Ø 800

Instalazione orizzontale Horizontal installation Installation horizontale Aufstellung horizontal Instalación horizontal Горизонтальный монтаж Instalacja pozioma	Ø 800 mm x n°	1 o	2 oo	3 ooo	4 oooo	5 ooooo	4 oo oo	6 ooo oo	8 oooo oo	10 ooooo oo	12 oooooo oo	14 ooooooo oo	16 oooooooo oo
(H)	A mm	2090	3690	5290	6890	8490	3690	5290	6890	8490	10090	11690	13290
	B mm	1600	3200	4800	6400	8000	3200	4800	6400	8000	9600	11200	12800
	C mm	—	—	—	—	3200	—	—	—	3200	4800	4800	6400
	D mm	—	—	—	—	4800	—	—	—	4800	4800	6400	6400

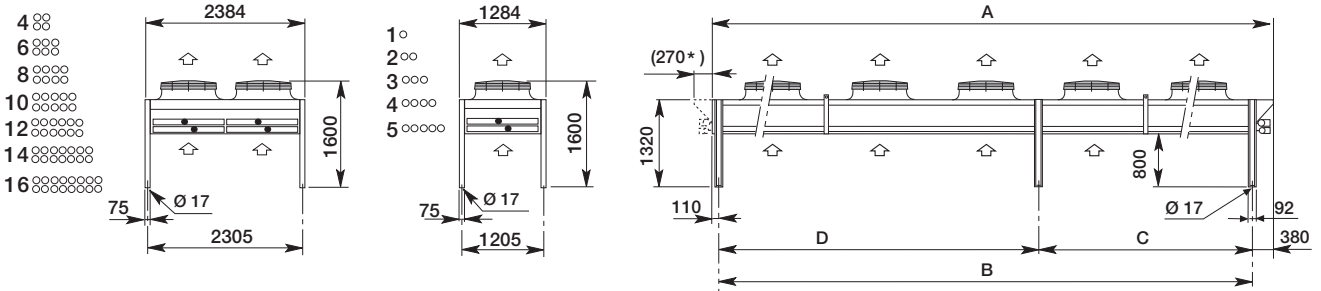

Installation verticale Vertical installation Installation verticale Aufstellung vertikal Instalación vertical Вертикальный монтаж Instalacja pionowa	Ø 800 mm x n°	1 o	2 oo	3 ooo	4 oooo	5 ooooo	4 oo oo	6 ooo oo	8 oooo oo
(V)	A mm	2090	3690	5290	6890	8490	3690	5290	6890
	B mm	1600	3200	4800	6400	8000	3200	4800	6400
	C mm	—	—	—	—	3200	—	—	3200
	D mm	—	—	—	—	4800	—	—	3200

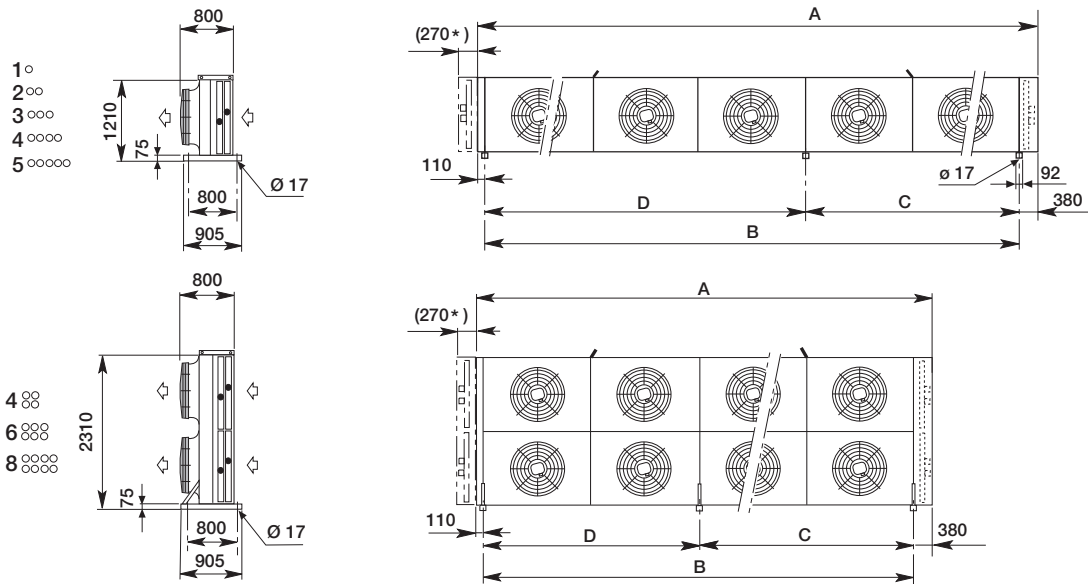

Posizione attacchi
Circuito: A, N, F Lati opposti*
Circuitos: B, C, D, E Stesso lato

Connection position
Circuit: A, N, F Opposite sides*
Circuits: B, C, D, E Same side

Position des connexions
Circuits: A, N, F Côtés opposés*
Circuits: B, C, D, E Même côté

Lage der Anschlüsse
Kreisläufe: A, N, F Zweiseitig*
Kreisläufe: B, C, D, E Einseitig

Posición de las conexiones
Circuitos: A, N, F Lados opuestos*
Circuitos: B, C, D, E Mismo lado

Вертикальный монтаж
Контур: A, N, F Противоположной стороне*
Контур: B, C, D, E С той же стороны

Instalacja pionowa
Obieg: A, N, F Przeciwnie strony*
Obieg: B, C, D, E Ta sama strona

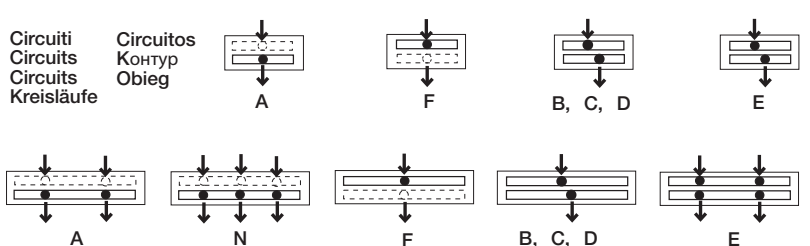

XAL Ø 900 - 1000 - XHL Ø 950

Installazione orizzontale Horizontal installation Installation horizontale Aufstellung horizontal Instalación horizontal Горизонтальный монтаж Instalacja pozioma	Ø 900-1000 mm x n°	1 o	2 oo	3 ooo	4 ooooo	5 oooooo	6 ooooooo	4 oo	6 ooo	8 ooooo	10 oooooo	12 ooooooo
(H) A mm		2623	4756	6889	9022	11155	13288	4756	6889	9022	11155	13288
B mm		2133	4266	6399	4266	4266	6399	4266	6399	4266	4266	6399
C mm		—	—	—	4266	6399	6399	—	—	4266	6399	6399

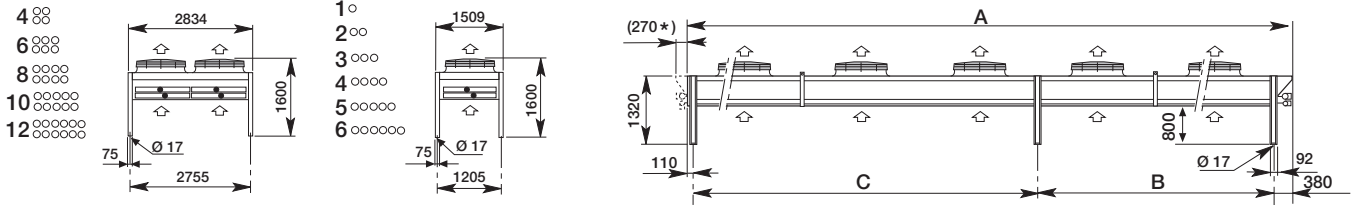

Installazione verticale Vertical installation Installation verticale Aufstellung vertikal Instalación vertical Вертикальный монтаж Instalacja pionowa	Ø 800 - 950 mm x n°	1 o	2 oo	3 ooo	4 ooooo	5 oooooo	6 ooooooo	4 oo	6 ooo	8 ooooo	10 oooooo	12 ooooooo
(M) A mm		2623	4756	6889	9022	11155	13288	4756	6889	9022	11155	13288
B mm		2133	4266	6399	4266	4266	6399	4266	2133	4266	4266	4266
C mm		—	—	—	4266	6399	6399	—	4266	4266	4266	4266

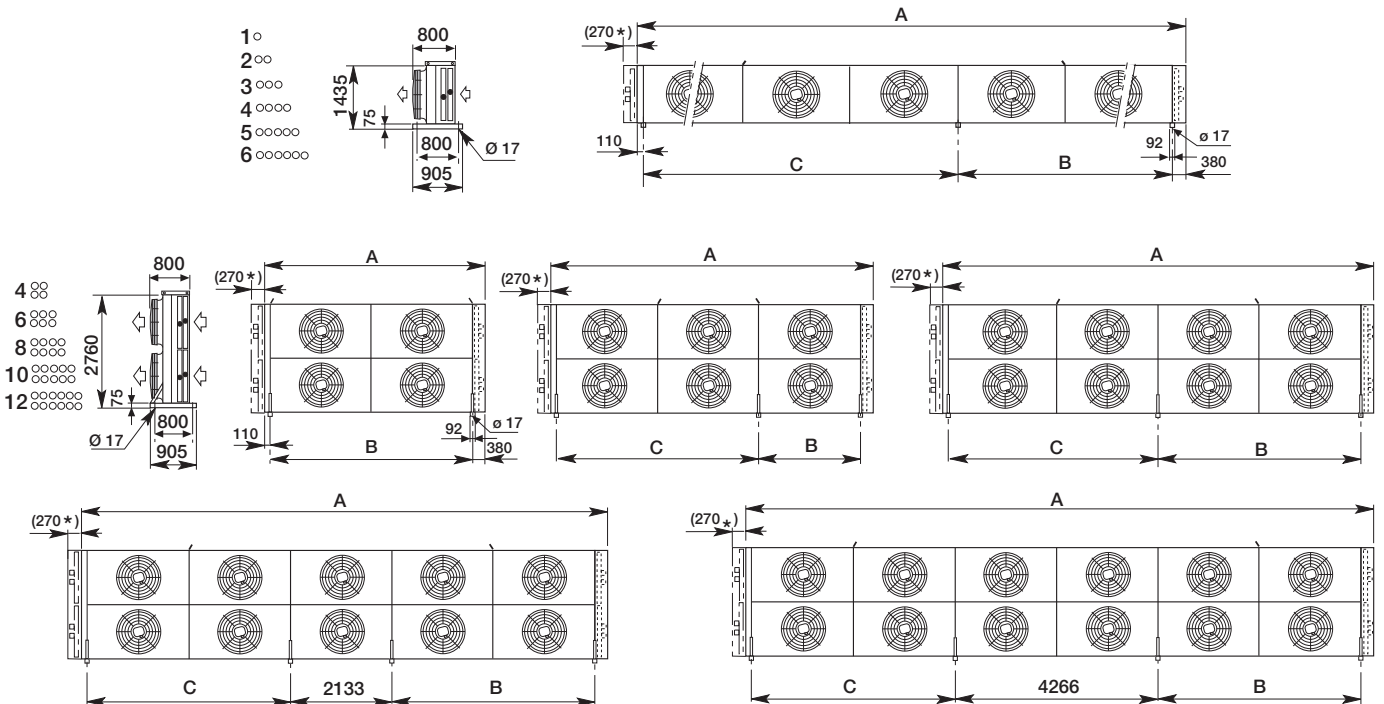

Posizione attacchi
Circuito: **A, N, F** Lati opposti *
Circuito: **B, C, D, E** Stesso lato

Connection position
Circuit: **A, N, F** Opposite sides *
Circuits: **B, C, D, E** Same side

Position des connexions
Circuits: **A, N, F** Côtés opposés *
Circuits: **B, C, D, E** Même côté

Lage der Anschlüsse
Kreisläufe: **A, N, F** Zweiseitig *
Kreisläufe: **B, C, D, E** Einseitig

Posición de las conexiones
Circuitos: **A, N, F** Lados opuestos *
Circuitos: **B, C, D, E** Mismo lado

Соединительная позиция
Контур: **A, N, F** Противоположной *
стороне
Контур: **B, C, D, E** С той же стороне

Położenie przyłączy
Obieg: **A, N, F** Przeciwne strony *
Obieg: **B, C, D, E** Ta sama strona

Circuiti / Circuits / Circuits / Kreisläufe / Circuitos / Контур / Obieg

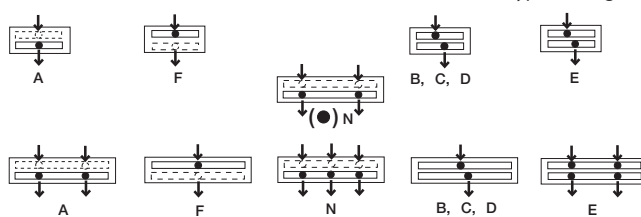

(●) N
Solo 2 attacchi per:
Only 2 connections for:
Seulement 2 raccords pour:
Nur 2 Anschlüsse für:
Solo 2 attacchi per:
Solo dos conexiones para:
_олько 2 подсоединения:
Tylko 2 przyłącza dla:

Modelli / Type / Modèle / Modell
Modelo / Модель / Model
1250N - 5260N - 8230N - 8240N
8250N

EHL Ø 900 - 950 - EAL Ø 800 - 900

Installazione orizzontale Horizontal installation Installation horizontale Aufstellung horizontal Instalación horizontal Горизонтальный монтаж Instalacja pozioma	(H)	Ø 800 - 950 mm x n°	1 o	2 oo	3 ooo	4 oooo	5 ooooo	6 oooooo	4 oo	6 ooo	8 ooooo	10 oooooo	12 oooooo
A	mm		2623	4756	6889	9022	11155	13288	4756	6889	9022	11155	13288
B	mm		2133	4266	6399	4266	4266	6399	4266	6399	4266	4266	6399
C	mm		-	-	-	4266	6399	6399	-	-	4266	6399	6399

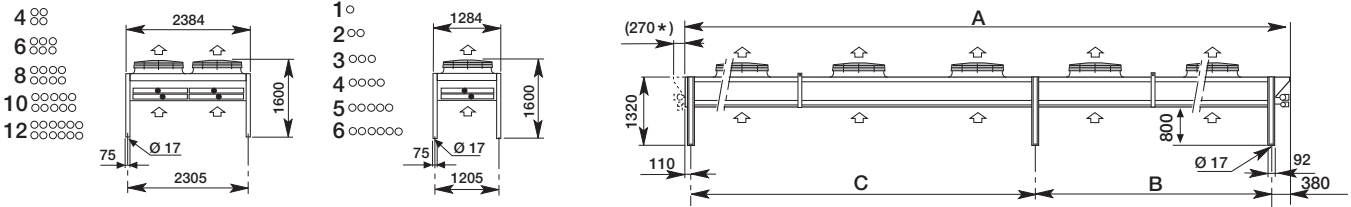

Installazione verticale Vertical installation Installation verticale Aufstellung vertikal Instalación vertical Вертикальный монтаж Instalacja pionowa	(M)	Ø 800 - 950 mm x n°	1 o	2 oo	3 ooo	4 oooo	5 ooooo	6 oooooo	4 oo	6 ooo	8 ooooo	10 oooooo	12 oooooo
A	mm		2623	4756	6889	9022	11155	13288	4756	6889	9022	11155	13288
B	mm		2133	4266	6399	4266	4266	6399	4266	2133	4266	4266	4266
C	mm		-	-	-	4266	6399	6399	-	4266	4266	4266	4266

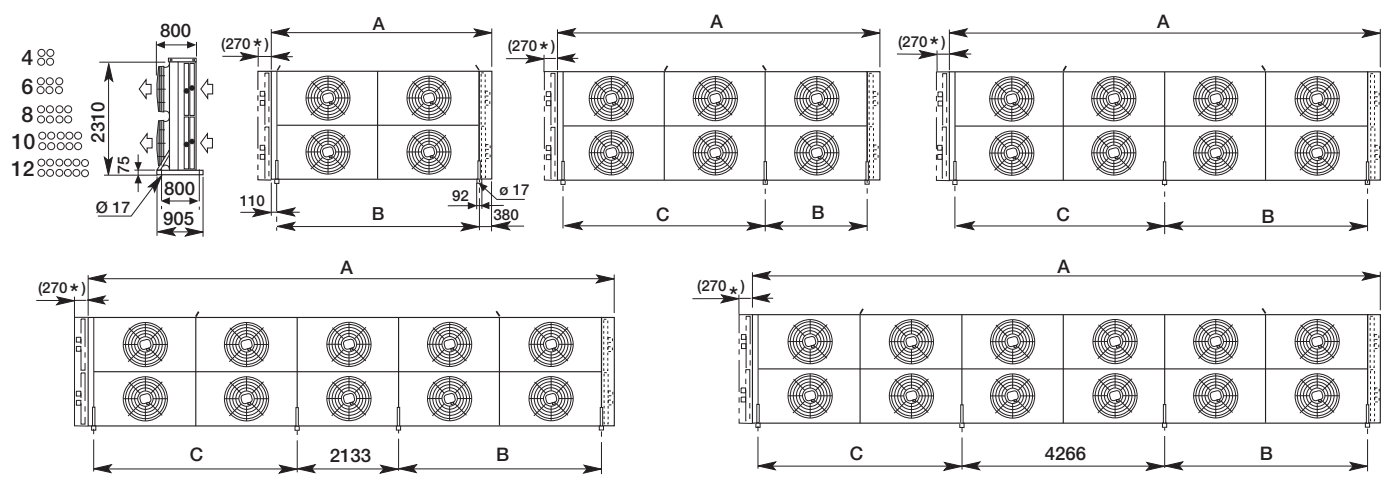
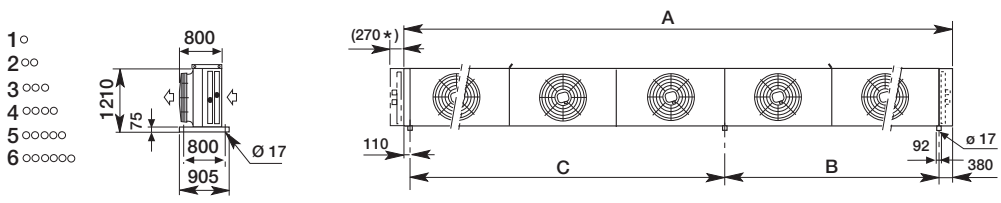

Posizione attacchi
Circuito: **A, N, F** Lati opposti*
Circuito: **B, C, D, E** Stesso lato

Connection position
Circuit: **A, N, F** Opposite sides*
Circuits: **B, C, D, E** Same side

Position des connexions
Circuits: **A, N, F** Côtés opposés*
Circuits: **B, C, D, E** Même côté

Lage der Anschlüsse
Kreisläufe: **A, N, F** Zweiseitig*
Kreisläufe: **B, C, D, E** Einseitig

Posición de las conexiones
Circuitos: **A, N, F** Lados opuestos*
Circuitos: **B, C, D, E** Mismo lado

Соединительная позиция
Контур: **A, N, F** Противоположной* стороне
Контур: **B, C, D, E** С той же стороны

Położenie przyłączy
Obieg: **A, N, F** Przeciwnie strony*
Obieg: **B, C, D, E** Ta sama strona

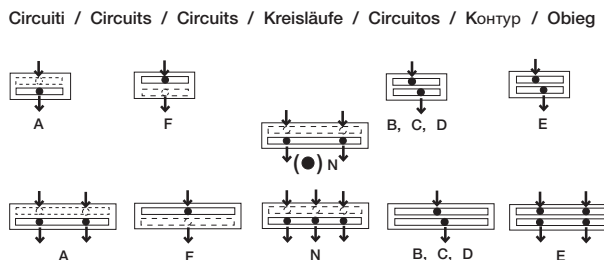

Modelli / Type / Modèle / Modell
Modelo / Модель / Model
1250N - 5260N - 8230N - 8240N
8250N - 9240N - 9250N - 9260N

Ø 500 - 630 - 800 - 900 - 1000

Guida distanze / Distances guide / Guide distances / Entfernungen Anleitung / Guia de distancias / Рекомендуемые расстояния / Minimalne odległości montażowe

Installazione orizzontale
Horizontal installation
Installation horizontale
Aufstellung horizontal
Instalación horizontal
Горизонтальный монтаж
Instalacja pozioma

(H)

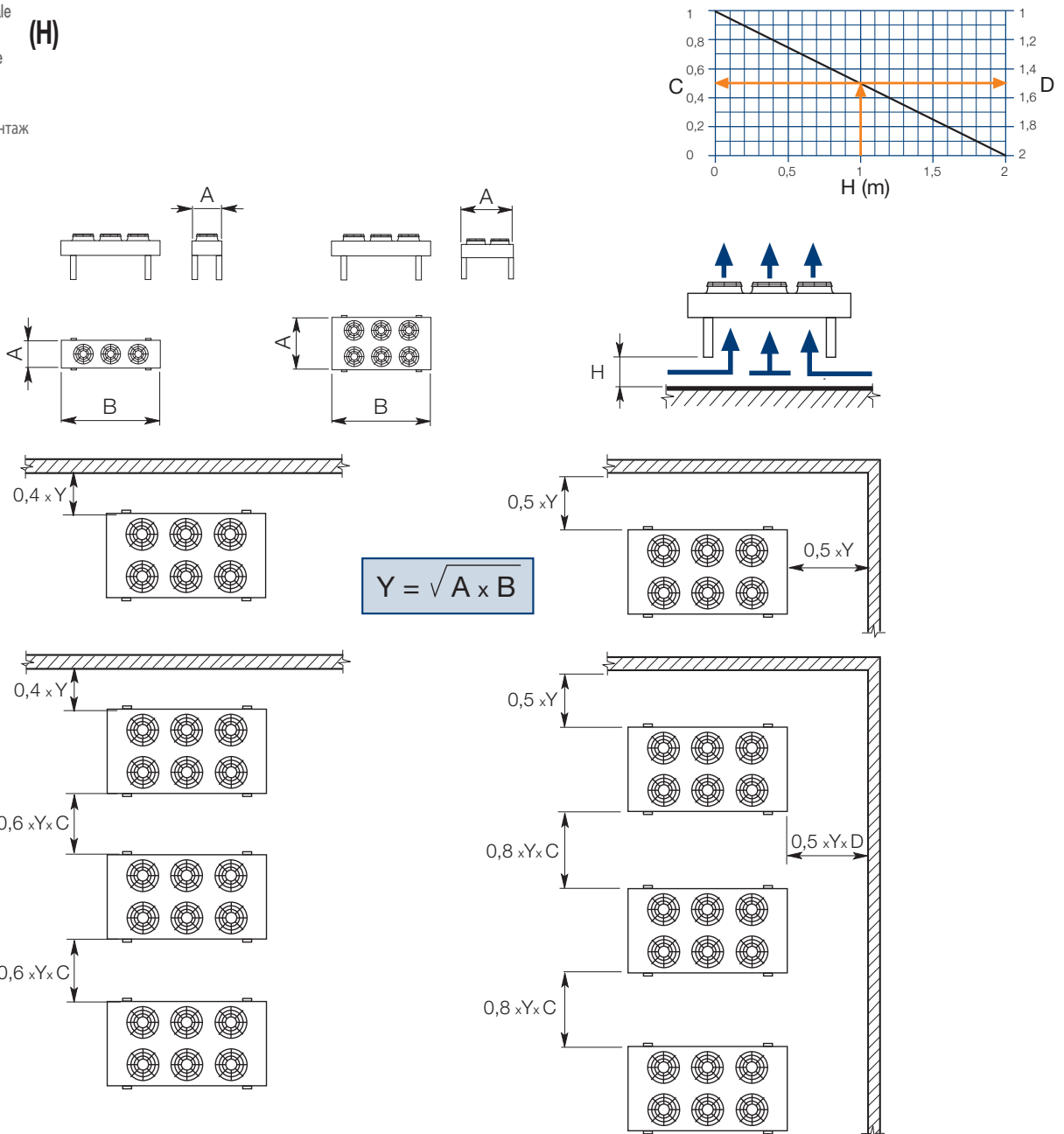

Ø 500 - 630 - 800 - 900 - 1000

Guida distanze / Distances guide / Guide distances / Entfernungen Anleitung / Guia de distancias / Рекомендуемые расстояния / Minimalne odległości montażowe

Installazione verticale
Vertical installation
Installation verticale
Aufstellung vertikal
Instalación vertical
Вертикальный монтаж
Instalacja pionowa

(M)

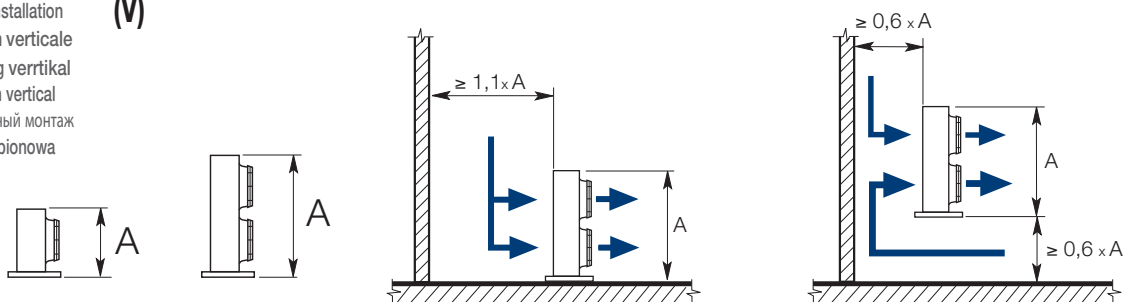

Livello pressione sonora / Sound pressure level / Niveau pression sonore / Schalldruckpegel
Nivel de presión sonora / Уровень звуковой мощности / Poziom mocy akustycznej

Livello pressione sonora sulla superficie del parallelepipedo indicato, con piano riflettente.

Sound pressure level on the indicated parallelepiped surface, with reflective plane.

Niveau pression sonore sur la surface du parallelepède indiqué, avec plan réfléchissant.

Schalldruckpegel auf die gezeigte quaderförmige Hüllfläche, mit reflektierender Ebene.

Nivel de presión sonora sobre las superficies del paralelepípedo indicadas, con plano reflectante.

Уровень звукового давления на поверхности указанного параллелипипеда с отражающими плоскостями.

Poziom ciśnienia akustycznego na powierzchni prostopadłościanu, z dolną płaszczyzną odbijającą.

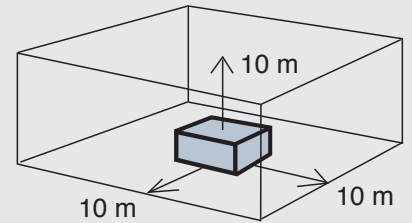

Livello potenza sonora / Sound power level / Niveau puissance sonore / Schalleistungspegel
Nivel de potencia sonora / Уровень звуковой мощности / Poziom mocy akustycznej

Livello potenza sonora riferita ad un ventilatore

Single fan sound power level

Niveau puissance sonore se réfère à un seul ventilateur

Schalleistungspegel für einen Ventilator

Nivel de potencia sonora para un solo ventilador

Уровень звуковой мощности для одного вентилятора

Poziom mocy akustycznej odnosi się do jednego wentylatora

Poli Подключение	Poles Poles	Pôles Pôles	Polig Polig	Polos Polos	SAL Ø 500						SAL Ø 630						SAL Ø 800					
					4P		6P		8P		6P		8P		12P		6P		8P			
Collegamento Подключение	Connection Pola	Connexion Pôles	Connexion Polig	Anschluß Polos	△	∩	△	∩	△	∩	△	∩	△	∩	△	∩	△	∩	△	∩		
					dB(A)	Tot.	79	75	69	65	61	56	74	68	66	59	55	48	79	73	73	67
					dB(A)	63Hz	44	45	43	40	40	33	48	42	44	34	36	28	53	51	50	46
					dB(A)	125Hz	60	62	55	47	44	44	48	42	44	34	44	35	59	52	52	51
					dB(A)	250Hz	68	62	57	56	50	45	61	58	56	49	48	42	68	60	61	55
					dB(A)	500Hz	73	68	62	59	55	50	69	63	62	54	50	43	73	66	67	62
					dB(A)	1kHz	75	71	65	61	56	52	70	63	60	55	51	44	76	69	69	63
					dB(A)	2kHz	72	67	62	59	56	51	66	59	56	49	45	36	73	67	65	59
					dB(A)	4kHz	71	66	59	54	48	43	59	51	49	41	35	27	66	58	58	53
					dB(A)	8kHz	64	58	48	43	36	29	55	48	45	37	35	36	61	53	55	48

Poli Подключение	Poles Poles	Pôles Pôles	Polig Polig	Polos Polos	EAL Ø 800				EHL Ø 900 (F)		EAL Ø 900				XAL Ø 900				XAL Ø 1000									
					6P		8P		6P		6P		8P		12P		4P		6P		8P		12P		6P			
Collegamento Подключение	Connection Pola	Connexion Pôles	Connexion Polig	Anschluß Polos	△	∩	△	∩	△	∩	△	∩	△	∩	△	∩	△	∩	△	∩	△	∩	△	∩	△	∩		
					dB(A)	Tot.	79	72	72	67	89	82	85	78	74	67	63	57	93	84	85	77	74	66	63	57	85	80
					dB(A)	63Hz	53	51	50	46	54	55	60	48	58	44	37	29	60	58	60	47	58	43	37	29	56	52
					dB(A)	125Hz	59	52	52	51	68	58	64	58	59	52	52	44	75	68	64	57	59	51	52	44	64	60
					dB(A)	250Hz	68	60	61	55	80	65	72	64	64	57	52	46	80	74	72	63	64	56	52	46	70	68
					dB(A)	500Hz	73	65	66	62	81	75	79	73	69	61	57	52	87	79	79	72	69	60	57	52	79	74
					dB(A)	1kHz	76	68	68	63	83	77	81	75	69	62	59	53	88	80	81	74	69	61	59	53	81	76
					dB(A)	2kHz	73	66	65	59	84	77	79	71	67	61	56	49	88	78	79	70	67	60	56	49	79	73
					dB(A)	4kHz	66	58	58	53	81	73	73	65	59	55	50	41	81	73	73	64	59	54	50	41	74	68
					dB(A)	8kHz	61	53	54	48	75	63	67	60	54	46	40	34	78	68	67	59	54	45	40	34	67	62

Dati elettrici di targa dei ventilatori 400V-3PH-50Hz

Questi dati, cui vanno aggiunte le tolleranze di norma, rappresentano i valori massimi di assorbimento nelle condizioni di esercizio più gravose e rappresentano i riferimenti per l'abbinamento di componenti elettrici non forniti da LU-VE.

Capacity plate of 400V-3PH-50Hz fans

These data, to which the standard allowances have to be added, are the maximum absorption values under the hardest operation conditions and serve as references to couple the electrical components which are not supplied by LU-VE.

Informations électriques indiquées sur la plaque des ventilateurs: 400V-3PH-50Hz

Ces données, auxquelles seront ajoutées les tolérances de la norme, représentent les valeurs maximales d'absorption dans les conditions de fonctionnement les plus difficiles et servent de référence pour le couplage des composants électriques non fournis par LU-VE.

Elektrische Daten auf dem Typenschild der Ventilatoren 400V-3PH-50Hz

Diesen Daten sind die Normtoleranz hinzuzufügen. Sie stellen die max. Aufnahmewerte bei extremen Betriebsbedingungen dar und dienen als Bezug für die Gruppierung mit Bezug für die Gruppierung mit Komponenten.

	SAL Ø 500				SAL Ø 630				SAL - EAL Ø 800				EHL Ø 900 (F)					
	4P		6P		8P		6P		8P		12P		6P		6P			
	△	∩	△	∩	△	∩	△	∩	△	∩	△	∩	△	∩	△	∩		
W	720	550	270	190	130	80	600	400	330	190	110	60	2000	1270	980	570	3300	1900
A	1,41	0,95	0,69	0,40	0,3	0,15	1,23	0,73	0,83	0,39	0,3	0,2	4,30	2,50	2,41	1,21	6,30	3,50

Correzione livello pressione sonora per distanza diversa da 10 m.

Sound pressure level correction for other than 10 m.

Correction niveau pression sonore pour distance différent de 10 m.

Pegeländerung für andere Entfernungen als 10 m.

Corrección de presión Sonora para distancias diferentes de 10 m.

Уровень звукового давления на расстоянии 10 м.

Współczynniki korekcyjne ciśnienia akustycznego dla odległości innej niż 10 m.

Ø500 - 630

m	2	3	5	10	15	20	30	40	60	80	100
dB (A)	12	9,5	5,5	0	-3	-5,5	-8,5	-11	-14	-16	-18

Ø800 - 900 - 1000

m	2	3	5	10	15	20	30	40	60	80	100
dB (A)	10	8	5	0	-3	-5,5	-8,5	-11	-14	-16	-18

Aumento del livello potenza sonora in funzione del numero dei ventilatori.

Sound power level increasing according to fan number.

Augmentation du niveau puissance sonore selon le nombre des ventilateurs.

Schalleistungspegel in Abhängigkeit von der Ventilatoranzahl.

El nivel de potencia sonora aumenta en función del número de ventiladores.

Увеличение уровня звуковой мощности в зависимости от количества вентиляторов.

Wzrost poziomu mocy akustycznej w zależności od ilości wentylatorów.

Ø500 - 630 - 800 - 900 - 1000

Ø N°	1	2	3	4	5	6	8	10	12	14	16
dB (A)	0	+3	+5	+6	+7	+8	+9	+10	+11	+12	+12

I livelli di potenza sonora sono stati provati secondo la norma EN 13487.

Sound power levels are tested according to EN 13487.

Les niveaux de puissance acoustique sont éprouvés selon la norme EN 13487.

Die Schalleistungspegel sind nach EN 13487 Norm geprüft.

Nivel de potencia Sonora comprobado de acuerdo con la norma EN 13487.

Уровни звуковой мощности проверены согласно нормативам EN 13487.

Pomiary poziomu mocy akustycznej zostały wykonane według normy EN 13487.



Datos de placa ventiladores de 400-3ph-50Hz

Estos datos deben sumarse a los valores indicados como standard, y son los valores máximos de consumo bajo las condiciones más agresivas, y sirven como referencia para calcular las otras componentes eléctricas que no sean suministradas por LU-VE.

Характеристики с этикетки двигателей 400V- 3PH- 50HZ

эти данные, принимают в расчёт нормативный запас отклонения, указывают макс. значения энерг. расхода при самых тяжёлых условиях работы и являются ссылкой для подбора электрических компонентов не поставляемых фирмой LU-VE.

Dane elektryczne dla wentylatorów 400V-3F-50Hz

Aby uzyskać wartości maksymalne poboru mocy, należy do poniższych wartości, dodać wyspecyfikowane w normach wskaźniki tolerancji. Wartości maksymalne występują w szczególnie trudnych warunkach pracy po zastosowaniu komponentów nie występujących w produktach LU-VE.

EAL Ø 900 - XAL Ø 900						XAL Ø 900		XAL Ø 1000	
6P		8P		12P		4P		6P	
△	∧	△	∧	△	∧	△	∧	△	∧
2450	1560	1110	680	310	190	5200	3000	2480	1820
5,20	2,90	2,70	1,36	0,83	0,39	8,70	5,00	5,63	3,42

Scelta rapida

Fattori di correzione

Selección rapida

Factor corrección

Quick selection

Correction factors

Мгновенный подбор

Фактор коррекции

Sélection rapide

Facteurs de correction

Szybki dobór

Współczynniki korekcyjne

Schnellauswahl

Korrekturfaktoren

TA (°C)	10	25	40
TWE/TWU (°C)	25/20	40/35	55/50
Fattore temperatura ambiente Ambient temperature factor Facteur température ambiante Faktor Umgebungstemperatur Factor de temperatura ambiente Фактор температуры окружающей среды Współczynnik temperatury otoczenia	0% Glycol		
FT	0,93	0,95	0,97
	34% Glycol		
	1,00	1,00	1,01

$\Delta TW/\Delta T$	0.15	0.20	0.25	0.30	0.33	0.35	0.40	0.45	0.50
Fattore differenze temperature Temperature differences factor Facteur différences température Faktor Temperaturdifferenzen Factor de diferencia de temperatura Фактор разности температур Współczynnik różnicy temperatur	FB								
	0,90	0,92	0,94	0,97	1,00	1,01	1,05	1,10	1,15

ΔT = differenza tra la temperatura dell'aria in entrata e la temperatura del fluido refrigerante in entrata.

ΔTW = differenza tra la temperatura del fluido refrigerante in entrata e la temperatura del fluido refrigerante in uscita.

ΔT = diferencia entre la temperatura de entrada del aire y la temperatura del fluido refrigerante en la entrada del equipo.

ΔTW = diferencia entre la temperatura del fluido refrigerante en la entrada y la temperatura del fluido refrigerante en la salida.

ΔT = difference between air inlet temperature and refrigerant fluid inlet temperature.

ΔTW = difference between refrigerant inlet fluid temperature and refrigerant outlet fluid temperature.

ΔT = разность между температурой воздуха на входе и температурой жидкости на входе.

ΔTW = разность между температурой жидкости на входе и температурой жидкости на выходе.

ΔT = différence entre la température d'entrée de l'air et la température d'entrée du fluide caloporteur.

ΔTW = différence entre la température d'entrée du fluide caloporteur et la température de sortie du fluide caloporteur.

ΔT = różnica pomiędzy temperaturą wejściową powietrza a temperaturą wlotową czynnika chłodzonego.

ΔTW = różnica pomiędzy temperaturą wlotową i temperaturą wylotową czynnika chłodzonego.

ΔT = differenz zwischen der Lufteintrittstemperatur und der Eintrittstemperatur des Kälteleiters.

ΔTW = differenz zwischen der Eintrittstemperatur des Kälteleiters und der Austrittstemperatur des Kälteleiters.

m	0	200	400	600	800	1000	1200	1400	1600	1800
Fattore altitudine Facteur altitude Altitud Wysokość	FA									
Altitude factor Faktor Meereshöhe Высота над уровне моря Wysokość	1,00	1,013	1,027	1,042	1,058	1,074	1,090	1,107	1,124	1,142

TWE/TWU (°C)	25/20	30/25	35/30	40/35	45/40	50/45	55/50
Fattore perdita di carico Pressure drop factor Facteur de la perte de charge Faktor Druckverlust Pérdida de carga Потери давления Spadek ciśnienia	0% Glycol						
FP	0,89	0,87	0,85	0,83	0,81	0,79	0,77
	34% Glycol						
	1,10	1,06	1,03	1,00	0,97	0,94	0,91

Dati di base	Basic data	Données de base	Basis Daten
Potenza termica (PT)	Thermal capacity (PT)	Puissance thermique (PT)	Wärmeleistung (PT)
Fluido refrigerante	Refrigerant fluid	Fluide caloporteur	Kälteleiter
Temperatura entrata fluido refrigerante	Refrigerant fluid inlet temperature	Température d'entrée du fluide caloporteur	Eintrittstemperatur des Kälteleiters
Temperatura uscita fluido refrigerante	Refrigerant fluid outlet temperature	Température de sortie du fluide caloporteur	Austrittstemperatur des Kälteleiters
Perdita di carico	Pressure drop	Perte de charge	Druckverlust
Temperatura aria in entrata (TA)	Air inlet temperature (TA)	Température d'entrée de l'air (TA)	Lufteintrittstemperatur (TA)
ΔT	ΔT	ΔT	ΔT
ΔTW	ΔTW	ΔTW	ΔTW
Altitudine	Altitude	Altitude	Meereshöhe
Livello pressione sonora a 15 m	Sound pressure level at 15 m	Niveau pression sonore à 15 m	Schalldruckpegel in 15 m

Selezione	Selection	Sélection	Typenauswahl
(P) Potenza raffreddatore di liquido	(P) Dry cooler capacity	(P) Puissance aéro-réfrigérant	(P) Flüssigkeits-Rückkühler Leistung
$P = PT \times 15/\Delta T \times FT \times FB \times FA = 280 \times 15/15 \times 1,00 \times 1,00 \times 1,027$			
Perdita di carico 30kPa x FP=30x1,03	Pressure drop 30kPa x FP=30x1,03	Perte de charge 30kPa x FP=30x1,03	Druckverlust 30kPa x FP=30x1,03
Livello pressione sonora	Sound pressure level	Niveau pression sonore	Schalldruckpegel dB(A) 49-3

Selezione

È disponibile un programma di selezione degli apparecchi operante in ambiente Windows (**REFRIGER**®).

Selection

A Windows software programme is available for unit selection (**REFRIGER**®).

Sélection

Un programme de calcul pour effectuer la sélection des aéro-réfrigérant sous Windows est disponible (**REFRIGER**®).

Auswahl

Für die Auslegung der Leistung ist ein Windows Computerprogramm erhältlich (**REFRIGER**®).

Selección

Está disponible un programa de selección de equipos operando bajo entorno Windows (**REFRIGER**®).

Подбор

Программное обеспечение Windows для оперативного выбора (**REFRIGER**®).

Dobór

Dostępny jest program doborowy pracujący w środowisku Windows służący do doboru urządzeń (**REFRIGER**®).



Esempio di ordinazione / Exemple de commande / Ordering example / Typenschlüssel / Ejemplo de pedido / Примерзаказа / Przykładowe zamówienie

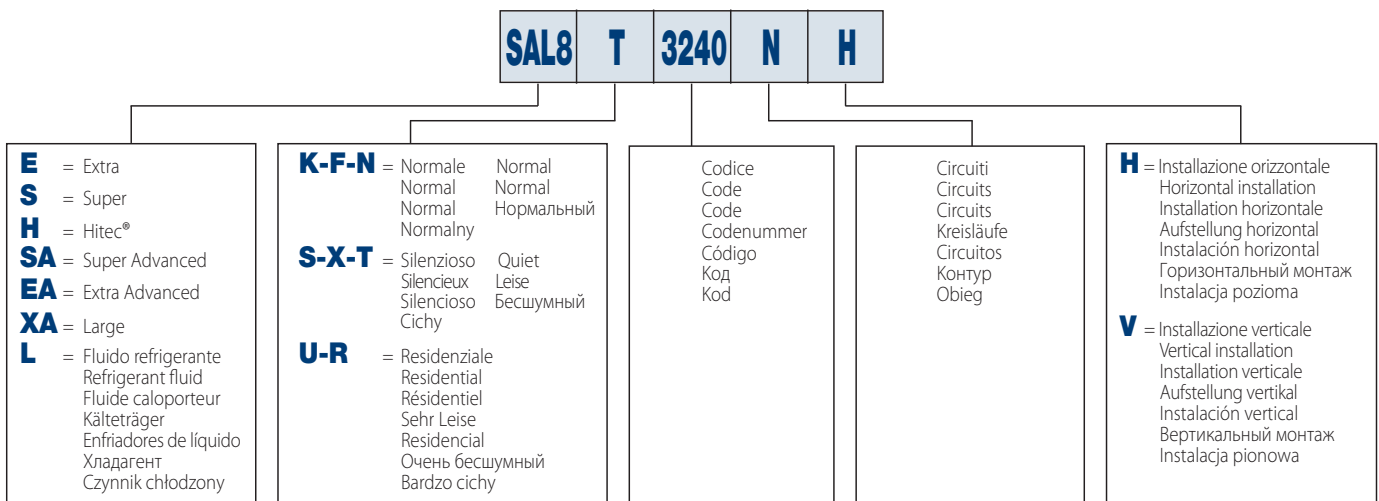

Datos básicos	Основные данные	Dane podstawowe	
Potencia (PT)	Тепловая производительность (PT)	Wydajność termiczna (PT)	= 280 kW
Fluido refrigerante	Хладагент	Чинник хлoдзoны	= 34% Glycol
Temperatura de entrada fluido refrigerante	Температура жидкости на входе	Температура wlotowa czynnika chłodzonego	= 35°C
Temperatura en la salida fluido refrigerante	Температура жидкости на выходе	Температура wylotowa czynnika chłodzonego	= 30°C
Pérdida de carga	Потери давления	Spadek ciśnienia	= 35 kPa
Temperatura de entrada del aire (TA)	Температура воздуха на входе (TA)	Температура wejściowa powietrza (TA)	= 20°C
ΔT	ΔT	ΔT	= 15 K
ΔTW	ΔTW	ΔTW	= 5 K
Altitud	Высота над уровнем моря	Wysokość	= 400 m
Nivel de presión sonora a 15 m	Уровень звукового давления на расстоянии 15 m	Poziom ciśnienia akustycznego w odl. 15 m	= 48 dB (A)

Selección	Подбор	Dobór	
Capacidad enfriador de líquido	Мощность охладителя жидкости	Wydajność suchej chłodnicy cieczy	= P
			= 288 kW (SAL8T3240N)
Pérdida de carga 30kPa x FP=30x1,03	Потеря заряда 30kPa x FP=30x1,03	Strata ciśnienia 30kPa x FP=30x1,03	= 31 kPa
Nivel de presión sonora	Уровень звукового давления	Poziom ciśnienia akustycznego	= 46 dB (A)

TWIN COIL DRY COOLERS



SAFETUBES SYSTEM® tube protection system

- "V" shape configuration
- High performance and reduced footprint



(Dry cooler with accessories)





● **XDHL** *Small Giants*

38 - 810 kW - 110 models

38 - 810 kW



Modello	Model	XDHLF (2,1 mm)	1114D	1115L	1124F	1125C	1134B	1135F														
Potenza	Capacity	□ kW (ΔT 15K) Glycol 34%	86	71	97	75	174	142	195	152	264	216	297	232								
Fluido refrigerante		m³/h Portata Flowrate	16,1	13,2	18,1	14,1	32,5	26,7	36,5	28,5	49,3	40,4	55,5	43,4								
Refrigerant fluid		kPa Perdita di carico Pressure drop	39	27	60	38	30	21	47	30	35	24	68	43								
Portata d'aria	Air quantity	m³/h	28600	21000	27100	19500	57200	42000	54200	39000	85800	63000	81300	58500								
Assorbimento motori		W	3250	2000	3250	2000	6500	4000	6500	4000	9750	6000	9750	6000								
Motor power consumption		A	6,0	3,5	6,0	3,5	12,0	7,0	12,0	7,0	18,0	10,5	18,0	10,5								
Livello pressione sonora	Sound pressure level	dB (A) (total)	57	50	57	50	60	53	60	53	62	55	62	55								
Attacchi	Connections	Ø"	2"	1 1/2"	2 1/2"	2 1/2"	2 1/2"	2 1/2"	2 1/2"	2 1/2"	2 1/2"	2 1/2"	2 1/2"	2 1/2"								
Modello	Model	XDHLN (2,1 mm)	2114D	2115L	2124F	2125C	2134B	2135F														
Potenza	Capacity	□ kW (ΔT 15K) Glycol 34%	79	66	87	70	159	133	177	142	241	202	269	216								
Fluido refrigerante		m³/h Portata Flowrate	14,8	12,3	16,3	13,2	29,8	24,9	33,0	26,6	45,1	37,8	50,2	40,5								
Refrigerant fluid		kPa Perdita di carico Pressure drop	33	24	50	34	25	18	39	26	29	21	56	38								
Portata d'aria	Air quantity	m³/h	24900	19100	23600	17900	49800	38200	47200	35800	74700	57300	70800	53700								
Assorbimento motori		W	2320	1560	2320	1560	4640	3120	4640	3120	6960	4680	6960	4680								
Motor power consumption		A	5,1	2,9	5,1	2,9	10,2	5,8	10,2	5,8	15,3	8,7	15,3	8,7								
Livello pressione sonora	Sound pressure level	dB (A) (total)	53	45	53	45	56	48	56	48	58	50	58	50								
Attacchi	Connections	Ø"	2"	1 1/2"	2 1/2"	2 1/2"	2 1/2"	2 1/2"	2 1/2"	2 1/2"	2 1/2"	2 1/2"	2 1/2"	2 1/2"								
Modello	Model	XDHLS (2,1 mm)	3114L	3115L	3124C	3125C	3134F	3135F														
Potenza	Capacity	□ kW (ΔT 15K) Glycol 34%	69	58	74	60	140	117	150	121	214	179	228	185								
Fluido refrigerante		m³/h Portata Flowrate	13,0	10,9	13,9	11,2	26,3	21,9	28,0	22,7	39,9	33,4	42,6	34,5								
Refrigerant fluid		kPa Perdita di carico Pressure drop	51	37	37	25	48	35	29	20	57	41	42	28								
Portata d'aria	Air quantity	m³/h	20000	15700	19100	14800	40000	31400	38200	29600	60000	47100	57300	44400								
Assorbimento motori		W	1640	1120	1640	1120	3280	2240	3280	2240	4920	3360	4920	3360								
Motor power consumption		A	3,7	2,1	3,7	2,1	7,3	4,2	7,3	4,2	11,0	6,3	11,0	6,3								
Livello pressione sonora	Sound pressure level	dB (A) (total)	47	41	47	41	50	44	50	44	52	46	52	46								
Attacchi	Connections	Ø"	1 1/2"	1 1/2"	2"	2 1/2"	2 1/2"	2 1/2"	2 1/2"	2 1/2"	2 1/2"	2 1/2"	2 1/2"	2 1/2"								
Modello	Model	XDHLX (2,1 mm)	4113L	4114L	4115L	4123C	4124C	4125D	4133F	4134F	4135C	4143B										
Potenza	Capacity	□ kW (ΔT 15K) Glycol 34%	53	44	60	48	61	47	106	89	121	95	124	95	162	135	185	143	186	143	215	181
Fluido refrigerante		m³/h Portata Flowrate	9,9	8,2	11,2	8,9	11,4	8,8	19,8	16,6	22,7	17,8	23,2	17,8	30,2	25,2	34,6	26,7	34,8	26,7	40,1	33,8
Refrigerant fluid		kPa Perdita di carico Pressure drop	65	46	39	26	26	16	64	46	38	24	66	40	80	57	46	29	59	37	53	39
Portata d'aria	Air quantity	m³/h	17200	13100	16300	12300	15400	11400	34400	26200	32600	24600	30800	22800	51600	39300	48900	36900	46200	34200	68800	52400
Assorbimento motori		W	820	520	820	520	820	520	1640	1040	1640	1040	1640	1040	2460	1560	2460	1560	2460	1560	3280	2080
Motor power consumption		A	2,2	1,1	2,2	1,1	2,2	1,1	4,4	2,2	4,4	2,2	4,4	2,2	6,6	3,3	6,6	3,3	6,6	3,3	8,8	4,4
Livello pressione sonora	Sound pressure level	dB (A) (total)	42	35	42	35	42	35	45	38	45	38	45	38	47	40	47	40	47	40	46	41
Attacchi	Connections	Ø"	1"	1 1/2"	1 1/2"	1 1/2"	1 1/2"	2"	2"	2"	2"	2"	2"	2"	2 1/2"	2 1/2"	2 1/2"	2 1/2"	2 1/2"	2 1/2"	2 1/2"	2 1/2"
Modello	Model	XDHLT (2,1 mm)	5113L	5114L	5115L	5123C	5124C	5125D	5133F	5134F	5135C	5143B										
Potenza	Capacity	□ kW (ΔT 15K) Glycol 34%	49	42	56	46	57	45	98	84	112	92	118	91	150	128	171	140	178	137	200	172
Fluido refrigerante		m³/h Portata Flowrate	9,1	7,9	10,4	8,6	10,6	8,5	18,3	15,8	20,9	17,3	22,0	17,0	28,0	24,0	31,9	26,3	33,4	25,5	37,4	32,1
Refrigerant fluid		kPa Perdita di carico Pressure drop	54	41	34	24	25	17	54	35	32	22	58	37	67	50	38	27	53	34	44	34
Portata d'aria	Air quantity	m³/h	15300	12100	14700	11500	14100	10900	30600	24200	29400	23000	28200	21800	45900	36300	44100	34500	42300	32700	61200	48400
Assorbimento motori		W	790	520	790	520	790	520	1580	1040	1580	1040	1580	1040	2370	1560	2370	1560	2370	1560	3160	2080
Motor power consumption		A	2,3	1,1	2,3	1,1	2,3	1,1	4,5	2,2	4,5	2,2	4,5	2,2	6,8	3,3	6,8	3,3	6,8	3,3	9,0	4,4
Livello pressione sonora	Sound pressure level	dB (A) (total)	40	35	40	35	40	35	43	38	43	38	43	38	45	40	45	40	45	40	46	41
Attacchi	Connections	Ø"	1"	1 1/2"	1 1/2"	1 1/2"	1 1/2"	2"	2"	2"	2"	2"	2"	2"	2 1/2"	2 1/2"	2 1/2"	2 1/2"	2 1/2"	2 1/2"	2 1/2"	2 1/2"
Modello	Model	XDHLU (2,1 mm)	6113L	6114M	6123C	6124D	6133F	6134C	6143B													
Potenza	Capacity	□ kW (ΔT 15K) Glycol 34%	38	32	42	33	78	66	84	66	117	99	126	101	156	132						
Fluido refrigerante		m³/h Portata Flowrate	7,1	6,1	7,8	6,2	14,5	12,3	15,8	12,4	21,8	18,4	23,6	19	29,2	24,8						
Refrigerant fluid		kPa Perdita di carico Pressure drop	36	27	60	40	36	26	58	37	44	33	54	36	30	22						
Portata d'aria	Air quantity	m³/h	10700	8500	10100	8000	21400	17000	20200	16000	32100	25500	30300	24000	42800	34000						
Assorbimento motori		W	270	170	270	170	540	340	540	340	810	510	810	510	1080	680						
Motor power consumption		A	0,8	0,4	0,8	0,4	1,6	0,8	1,6	0,8	2,4	1,2	2,4	1,2	3,2	1,6						
Livello pressione sonora	Sound pressure level	dB (A) (total)	31	25	31	25	34	28	34	28	36	30	36	30	37	31						
Attacchi	Connections	Ø"	1"	1"	1 1/2"	1 1/2"	2"	2"	2"	2"	2"	2"	2"	2 1/2"	2 1/2"							
DATI COMUNI / COMMON DATA																						
Elettroventilatori		Ø 800-900 mm x n°	1 o	1 o	1 o	2 oo	2 oo	2 oo	2 oo	3 ooo	3 ooo	3 ooo	4 oooo									
Fans		Collegamento Connection	△	△	△	△	△	△	△	△	△	△	△									
Superficie esterna	External surface	m²	112	168	224	224	335	447	335	503	671	447										
Superficie interna	Internal surface	m²	7,2	10,8	14,5	14,5	21,6	28,8	21,6	32,5	43,3	28,8										
Volume circuito	Circuit volume	dm³	2 x 11	2 x 16	2 x 21	2 x 21	2 x 29	2 x 40	2 x 31	2 x 44	2 x 62	2 x 44										
Peso	Weight	kg	222	244	265	383	425	468	543	607	672	701										

VARIANTI COSTRUTTIVE
CONSTRUCTION VARIANTS



Potenza con tubi puliti
 Capacity with clean tubes

Attacchi lati opposti: A-F-N
Connections opposite sides: A-F-N

1144B				1145B				1154A				1155E				1164A				1165N				1174A				1175N				1184A				1185N															
362	296	398	311					440	361	507	395					537	439	592	463					640	523	704	550					737	602	810	633																
67,7	55,2	74,3	58,1					82,4	67,4	94,8	73,9					100,5	82,2	110,7	86,5					119,6	97,8	131,6	102,8					137,8	112,6	151,5	118,2																
74	51	73	44					22	15	89	58					36	25	20	13					54	37	30	19					76	52	44	28																
114400	84000	108400	78000					143000	105000	135500	97500					171600	126000	162600	117000					200200	147000	189700	136500					228800	168000	216800	156000																
13000	8000	13000	8000					16250	10000	16250	10000					19500	12000	19500	12000					22750	14000	22750	14000					26000	16000	26000	16000																
24,0	14,0	24,0	14,0					30,0	17,5	30,0	17,5					36,0	21,0	36,0	21,0					42,0	24,5	42,0	24,5					48,0	28,0	48,0	28,0																
63	56	63	56					64	57	64	57					64	57	64	57					65	58	65	58					65	58	65	58																
2 1/2"		2 1/2"						4"		4"						4"		2 x 4"						4"		2 x 4"						4"		2 x 4"																	
2144B				2145B				2154A				2155E				2164A				2165N				2174A				2175N				2184A				2185N															
331	277	360	290					403	338	458	369					491	412	536	432					585	490	637	514					674	564	733	591																
61,8	51,8	67,2	54,2					75,4	63,2	85,8	69,0					91,9	77,0	100,2	80,8					109,4	91,6	119,1	96,0					126,0	105,5	137,1	110,4																
63	45	61	39					19	14	74	50					30	22	17	11					46	33	25	17					65	46	36	24																
99600	76400	94400	71600					124500	95500	118000	89500					149400	114600	141600	107400					174300	133700	165200	125300					199200	152800	188800	143200																
9280	6240	9280	6240					11600	7800	11600	7800					13920	9360	13920	9360					16240	10920	16240	10920					18560	12480	18560	12480																
20,4	11,6	20,4	11,6					25,5	14,5	25,5	14,5					30,6	17,4	30,6	17,4					35,7	20,3	35,7	20,3					40,8	23,2	40,8	23,2																
59	51	59	51					60	52	60	52					60	52	60	52					61	53	61	53					61	53	61	53																
2 1/2"		2 1/2"						4"		4"						4"		2 x 4"						4"		2 x 4"						4"		2 x 4"																	
3144B				3145B				3154B				3155E				3164A				3165E				3174A				3175N				3184A				3185N															
286	239	306	247					365	305	389	315					425	356	470	380					505	423	541	439					582	487	623	504																
53,4	44,7	57,1	46,3					68,2	57,0	72,7	58,8					79,4	66,6	87,9	71,0					94,5	79,2	101,2	82,1					108,8	91,1	116,4	94,3																
48	34	45	29					86	62	56	38					23	17	90	61					35	25	19	13					49	35	27	18																
80000	62800	76400	59200					100000	78500	95500	74000					120000	94200	114600	88800					140000	109900	133700	103600					160000	125600	152800	118400																
6560	4480	6560	4480					8200	5600	8200	5600					9840	6720	9840	6720					11480	7840	11480	7840					13120	8960	13120	8960																
14,6	8,4	14,6	8,4					18,3	10,5	18,3	10,5					21,9	12,6	21,9	12,6					25,6	14,7	25,6	14,7					29,2	16,8	29,2	16,8																
53	47	53	47					54	48	54	48					54	48	54	48					55	49	55	49					55	49	55	49																
2 1/2"		2 1/2"						2 1/2"		4"						4"		4"						4"		2 x 4"						4"		2 x 4"																	
4144B				4145F				4153A				4154B				4155B				4163A				4164A				4165E				4173A				4174A				4175N				4184A				4185N			
245	189	248	190	262	220	314	239	315	237	323	268	368	280	374	285	379	317	431	329	432	328	499	378	501	376					499	378	501	376																		
45,7	35,3	46,3	35,5	48,9	41,1	58,5	44,6	58,8	44,3	60,1	50	68,6	52,4	70	53,3	70,6	59,1	80,4	61,5	80,7	61,3	93	70,6	93,6	70,3					93	70,6	93,6	70,3																		
38	23	62	38	24	17	69	42	49	29	38	27	19	11	57	35	55	40	27	17	13	8	39	23	19	11					39	23	19	11																		
65200	49200	61600	45600	86000	65500	81500	61500	77000	57000	103200	78600	97800	73800	92400	68400	120400	91700	114100	86100	107800	79800	130400	98400	123200	91200					130400	98400	123200	91200																		
3280	2080	3280	2080	4100	2600	4100	2600	4100	2600	4920	3120	4920	3120	4920	3120	5740	3640	5740	3640	5740	3640	6560	4160	6560	4160					6560	4160	6560	4160																		
8,8	4,4	8,8	4,4	11	5,5	11	5,5	11	5,5	13,2	6,6	13,2	6,6	13,2	6,6	15,4	7,7	15,4	7,7	15,4	7,7	17,6	8,8	17,6	8,8					17,6	8,8	17,6	8,8																		
48	41	48	41	49	42	49	42	49	42	49	42	49	42	49	42	50	43	50	43	50	43	50	43	50	43					50	43	50	43																		
2 1/2"		2 1/2"		2 1/2"		2 1/2"		2 1/2"		2 1/2"		4"		4"		2 1/2"		4"		4"		2 x 4"		4"		2 x 4"						4"		2 x 4"																	
5144B				5145F				5153B				5154B				5155B				5163A				5164B				5165B				5173A				5174A				5175B				5184A				5185N			
228	188	238	182	256	219	291	239	296	227	297	255	351	289	357	273	354	304	404	333	417	320	465	383	469	361					465	383	469	361																		
42,6	35,2	44,4	34,1	47,8	40,9	54,4	44,7	55,3	42,4	55,5	47,7	65,7	54,1	66,7	51,1	66,1	56,8	75,5	62,3	78,0	59,8	87	71,7	87,8	67,4					87	71,7	87,8	67,4																		
32	22	55	35	82	62	57	40	47	32	33	26	91	64	73	47	49	37	23	16	84	69	32	23	16	11					32	23	16	11																		
58800	46000	56400	43600	76500	60500	73500	57500	70500	54500	91800	72600	88200	69000	84600	65400	107100	84700	102900	80500	98700	76300	117600	92000	112800	87200					117600	92000	112800	87200																		
3160	2080	3160	2080	3950	2600	3950	2600	3950	2600	4740	3120	4740	3120	4740	3120	5530	3640	5530	3640	5530	3640	6320	4160	6320	4160					6320	4160	6320	4160																		
9,0	4,4	9,0	4,4	11,3	5,5	11,3	5,5	11,3	5,5	13,5	6,6	13,5	6,6	13,5	6,6	15,8	7,7	15,8	7,7	15,8	7,7	18,0	8,8	18,0	8,8					18,0	8,8	18,0	8,8																		
46	41	46	41	47	42	47	42	47	42	47	42	47	42	47	42	48	43	48	43	48	43	48	43	48	43					48	43	48	43																		
2 1/2"		2 1/2"		2 1/2"		2 1/2"		2 1/2"		2 1/2"		2 1/2"		2 1/2"		2 1/2"		4"		4"		2 x 4"		4"		2 x 4"						4"		2 x 4"																	
6144F				6153B				6154B				6163A				6164B				6173A				6174B				6183A				6184A																			
170	135			199	169	214	168			235	199	260	203			280	237	307	237	322	272	345	268					322	272	345	268																				
31,8	25,3			37,3	31,5	39,9	31,5			44	37,2	48,7	37,9			52,3	44,2	57,5	44,4	60,1	50,9	64,6	50					60,1	50,9	64,6	50																				
49	32			55	41	34	22			21	15	56	35			31	23	85	53	44	32	20	12					44	32	20	12																				
40																																																			

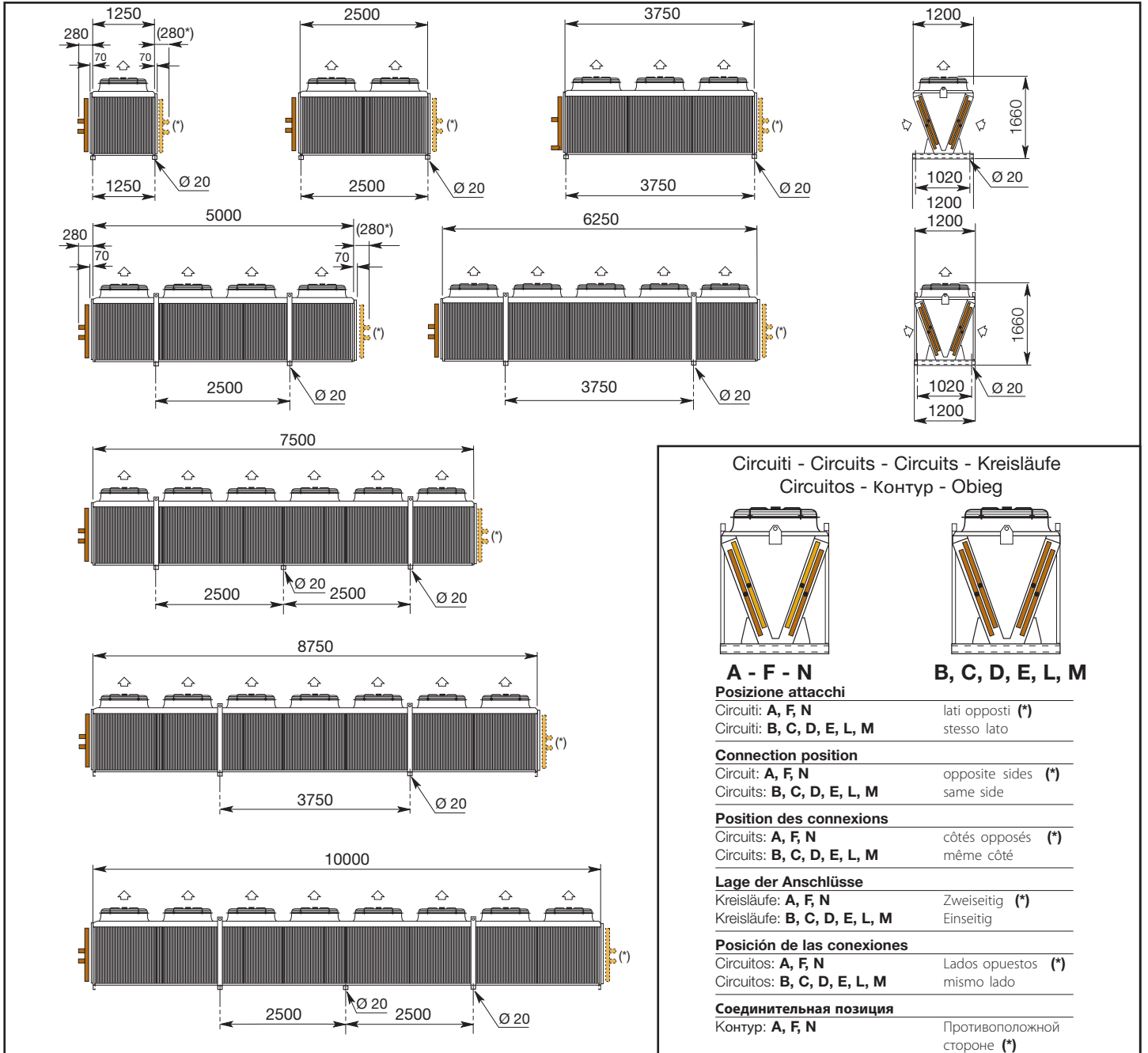

Guida distanze / Distances guide / Guide distances / Entfernungen Anleitung
Guía de distancias / Рекомендуемые расстояния
Minimalne odległości montażowe

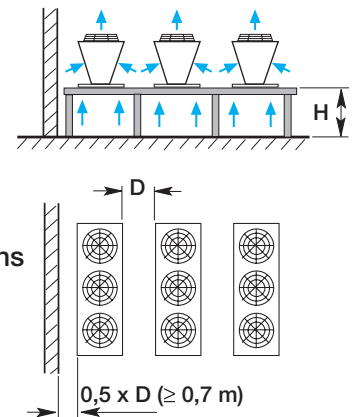
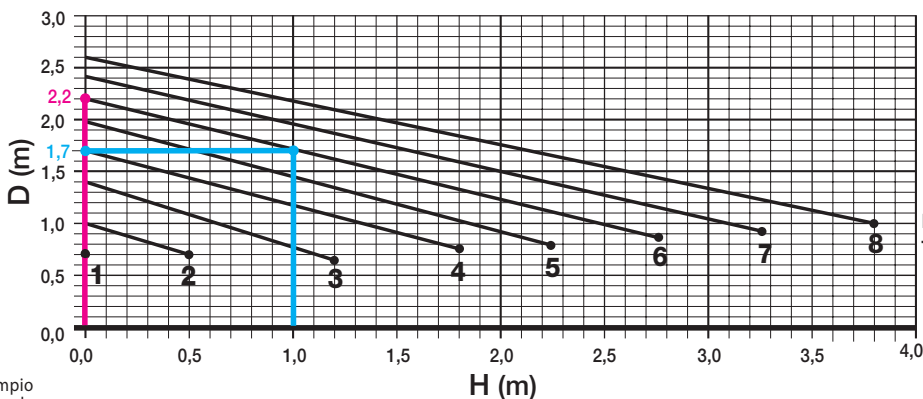

Esempio
 Example
 Exemple
 Beispiel
 Ejemplo
 Пример
 Przykład

n° fans	6	6
H (m)	0,0	1,0
D (m)	2,2	1,7

1

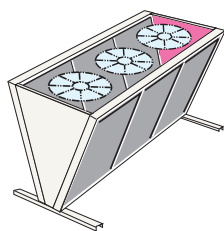

- **VERSIONE STANDARD:** separazione flusso d'aria per file di ventilatori
- **STANDARD VERSION:** fan section division for each fan row
- **VERSION STANDARD:** cloisonnement par rang de ventilateurs
- **STANDARD AUSFÜHRUNG** mit Trennwänden je Ventilatorreihe
- **VERSIÓN STANDARD:** separación flujo de aire para cada fila de ventiladores
- **СТАНДАРТНАЯ ВЕРСИЯ:** разделения воздушных потоков
- **WERSJA STANDARDOWA:** przegroda pomi ędzy rz ędami wentylatorów

2

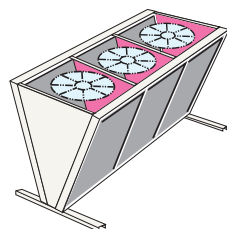

- **VERSIONE SPECIALE:** separatore di flusso d'aria per ogni ventilatore
- **SPECIAL VERSION:** fan section division for each fan
- **VERSIONSPECIAL:** cloisonnement par ventilateur
- **SPEZIALAUSFÜHRUNG** mit Trennwänden zwischen den Ventilatorsektionen je Ventilator
- **VERSION ESPECIAL:** separación por cada ventilador
- **СПЕЦИАЛЬНОЕ ИСПОЛНЕНИЕ:** разделитель воздушного потока для каждого из вентиляторов
- **WERSJE SPECJALNE:** przegrody indywidualne dla ka żdego wentylatora

Esempio di ordinazione
Ordering example
Exemple de commande
Typenschlüssel
Ejemplo de pedido
Пример заказа
Nomenklatura

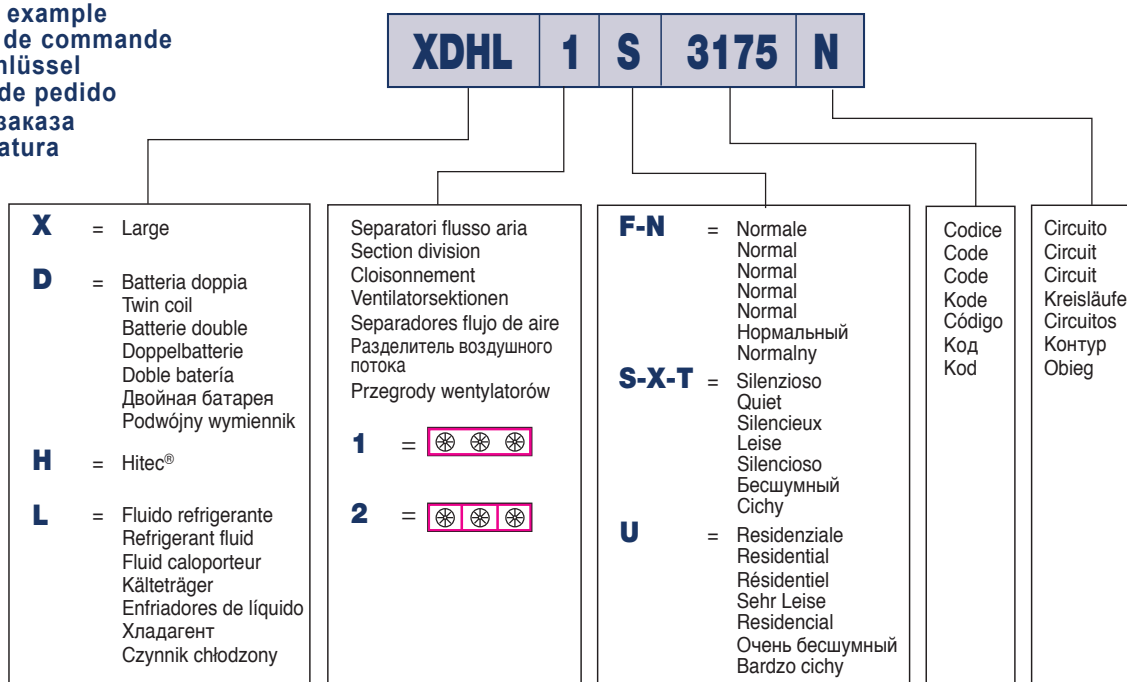

Selezione

È disponibile un programma di selezione degli apparecchi operante in ambiente Windows (REFRIGER®).

Selection

A Windows software programme is available for unit selection (REFRIGER®).

Sélection

Un programme de calcul pour effectuer la sélection des aéro-réfrigérant sous Windows est disponible (REFRIGER®).

Auswahl

Für die Auslegung der Leistung ist ein Windows Computerprogramm erhältlich (REFRIGER®).



Selección

Está disponible un programa de selección de equipos operando bajo entorno Windows (REFRIGER®).

Подбор

Программное обеспечение Windows для оперативного выбора (REFRIGER®).

Dobór

Dostępny jest program doborowy pracujący w środowisku Windows służący do doboru urządzeń (REFRIGER®).

**Livello pressione sonora / Sound pressure level / Niveau pression sonore / Schalldruckpegel
Nivel de presión sonora / Уровень звуковой мощности / Poziom mocy akustycznej**

Livello pressione sonora sulla superficie del parallelepipedo indicato, con piano riflettente.

Sound pressure level on the indicated parallelepiped surface, with reflective plane.

Niveau pression sonore sur la surface du parallelepède indiquè, avec plan réfléchissant.

Schalldruckpegel auf die gezeigte quaderförmige Hüllfläche, mit reflektierender Ebene.

Nivel de presión sonora sobre las superficies del paralelepèdo indicadas, con plano reflectante.

Уровень звукового давления на поверхности указанного параллелипипеда с отражающими плоскостями.

Poziom ciśnienia akustycznego na powierzchni prostopadłościanu, z dolną płaszczyzną odbijającą.

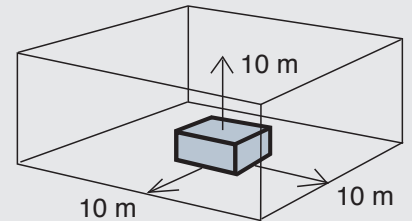

**Livello potenza sonora / Sound power level / Niveau puissance sonore / Schalleistungspegel
Nivel de potencia sonora / Уровень звуковой мощности / Poziom mocy akustycznej**

Livello potenza sonora riferita ad un ventilatore

Single fan sound power level

Niveau puissance sonore se réfère à un seul ventilateur

Schalleistungspegel für einen Ventilator

Nivel de potencia sonora para un solo ventilador

Уровень звуковой мощности для одного вентилятора

Poziom mocy akustycznej odnosi się do jednego wentylatora

Elettroventilatori Electroventiladores		Fans Вентиляторы		Ventilateurs Wentylatory		Ventilatoren		Ø 800				Ø 900							
Modello Model	Model	Modèle	Modell	Modelo	Модель	XDHLS		XDHLT		XDHLF		XDHLN		XDHLX		XDHLU			
Poli Подключение	Poles	Pôles Pola	Polig	Polos		6P		8P		6P		6P		8P		12P			
Collegamento Подключение	Connection Połączenie	Connexion	Anschluß	Conexión		△	∩	△	∩	△	∩	△	∩	△	∩	△	∩		
						dB(A)	Tot.	79	72	72	67	89	82	85	77	74	67	63	57
						dB(A)	63Hz	53	51	50	46	54	55	60	47	58	44	37	29
						dB(A)	125Hz	59	52	52	51	68	58	64	57	59	52	52	44
						dB(A)	250Hz	68	60	61	55	80	65	72	63	64	57	52	46
						dB(A)	500Hz	73	65	66	62	81	75	79	72	69	61	57	52
						dB(A)	1kHz	76	68	68	63	83	77	81	74	69	62	59	53
						dB(A)	2kHz	73	66	65	59	84	77	79	70	67	61	56	49
						dB(A)	4kHz	66	58	58	53	81	73	73	64	59	55	50	41
						dB(A)	8kHz	61	53	54	48	75	63	67	59	54	46	40	34

Dati elettrici di targa dei ventilatori 400V-3PH-50Hz

Questi dati, cui vanno aggiunte le tolleranze di norma, rappresentano i valori massimi di assorbimento nelle condizioni di esercizio più gravose e rappresentano i riferimenti per l'abbinamento di componenti elettrici non forniti da LU-VE.

Capacity plate of 400V-3PH-50Hz fans

These data, to which the standard allowances have to be added, are the maximum absorption values under the hardest operation conditions and serve as references to couple the electrical components which are not supplied by LU-VE.

Informations électriques indiquées sur la plaque des ventilateurs: 400V-3PH-50Hz

Ces données, auxquelles seront ajoutées les tolérances de la norme, représentent les valeurs maximales d'absorption dans les conditions de fonctionnement les plus difficiles et servent de référence pour le couplage des composants électriques non fournis par LU-VE.

Elektrische Daten auf dem Typenschild der Ventilatoren 400V-3PH-50Hz

Diesen Daten sind die Normtoleranz hinzuzufügen. Sie stellen die max. Aufnahmewerte bei extremen Betriebsbedingungen dar und dienen als Bezug für die Gruppierung mit Bezug für die Gruppierung mit Komponenten.

	Ø 800				Ø 900							
	XDHLS		XDHLT		XDHLF		XDHLN		XDHLX		XDHLU	
	6P		8P		6P		6P		8P		12P	
	△	∩	△	∩	△	∩	△	∩	△	∩	△	∩
W	2000	1270	980	570	3300	1900	2450	1560	1110	680	310	190
A	4,30	2,50	2,41	1,21	6,30	3,50	5,20	2,90	2,70	1,36	0,83	0,39

Correzione livello pressione sonora per distanza diversa da 10 m.

Sound pressure level correction for other than 10 m.

Correction niveau pression sonore pour distance différent de 10 m.

Pegeländerung für andere Entfernungen als 10 m.

Corrección de presión Sonora para distancias diferentes de 10 m.

Уровень звукового давления на расстоянии 10 м.

Współczynniki korekcyjne ciśnienia akustycznego dla odległości innej niż 10 m.

XDHL Ø 800 - 900

m	2	3	5	10	15	20	30	40	60	80	100
dB (A)	10	8	5	0	-3	-5,5	-8,5	-11	-14	-16	-18

Aumento del livello potenza sonora in funzione del numero dei ventilatori.

Sound power level increasing according to fan number.

Augmentation du niveau puissance sonore selon le nombre des ventilateurs.

Schalleistungspegel in Abhängigkeit von der Ventilatoranzahl.

El nivel de potencia sonora aumenta en función del número de ventiladores.

Увеличение уровня звуковой мощности в зависимости от количества вентиляторов.

Wzrost poziomu mocy akustycznej w zależności od ilości wentylatorów.

XDHL Ø 800 - 900								
Ø N°	1	2	3	4	5	6	7	8
dB (A)	0	+3	+5	+6	+7	+8	+8	+9

I livelli di potenza sonora sono stati provati secondo la norma EN 13487.

Sound power levels are tested according to EN 13487.

Les niveaux de puissance acoustique sont éprouvés selon la norme EN 13487.

Die Schalleistungspegel sind nach EN 13487 Norm geprüft.

Nivel de potencia Sonora comprobado de acuerdo con la norma EN 13487.

Уровни звуковой мощности проверены согласно нормативам EN 13487.

Pomiary poziomu mocy akustycznej zostały wykonane według normy EN 13487.



Datos de placa ventiladores de 400-3ph-50Hz

Estos datos deben sumarse a los valores indicados como standard, y son los valores máximos de consumo bajo las condiciones más agresivas, y sirven como referencia para calcular las otras componentes eléctricas que no sean suministradas por LU-VE.

Характеристики с этикетки двигателей 400V- 3PH- 50HZ

эти данные, принимают в расчёт нормативный запас отклонения, указывают макс. значения энерго расхода при самых тяжёлых условиях работы и являются ссылкой для подбора электрических компонентов не поставляемых фирмой LU-VE.

Dane elektryczne dla wentylatorów 400V-3F-50Hz

Aby uzyskać wartości maksymalne poboru mocy, należy do poniższych wartości, dodać wyspecyfikowane w normach wskaźniki tolerancji. Wartości maksymalne występują w szczególnie trudnych warunkach pracy po zastosowaniu komponentów nie występujących w produktach LU-VE.

TWIN COIL DRY COOLERS



SAFETUBES SYSTEM® tube protection system



SMART® innovative structure system

- "V" shape configuration
- Large capacity
- Low noise configuration



(Dry cooler with accessories)



● **EHL D** *Giants*

159 - 1867 kW - 96 models

159 - 1867 kW

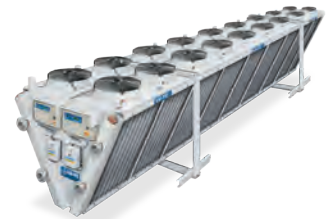

Modello	Model	EHLDF (2,1 mm)	1226F	1227F	1236B	1237B	1246B	1247E	1256A							
Potenza	Capacity	□ kW (ΔT 15K) Glycol 34%	359	294	395	310	544	445	599	469	738	603	810	634	894	732
Fluido refrigerante	m³/h Portata Flowrate		67,2	55,0	74,0	58,0	101,7	83,2	111,9	87,7	138,0	112,7	151,5	118,5	167,1	136,9
Refrigerant fluid	kPa Perdita di carico Pressure drop		40	28	31	20	46	32	41	26	98	67	59	38	28	19
Portata d'aria	Air quantity	m³/h	120400	88800	114400	82800	180600	133200	171600	124200	240800	177600	228800	165600	301000	222000
Assorbimento motori	W		13000	8000	13000	8000	19500	12000	19500	12000	26000	16000	26000	16000	32500	20000
Motor power consumption	A		24,0	14,0	24,0	14,0	36,0	21,0	36,0	21,0	48,0	28,0	48,0	28,0	60,0	35,0
Livello pressione sonora	Sound pressure level	dB (A) (total)	63	56	63	56	65	58	65	58	66	59	66	59	67	60
Attacchi	Connections	Ø"	4"	4"	4"	4"	4"	4"	4"	4"	4"	4"	2 x 4"	2 x 4"	2 x 4"	2 x 4"
Modello	Model	EHLDN (2,1 mm)	2226F	2227F	2236B	2237B	2246B	2247E	2256A							
Potenza	Capacity	□ kW (ΔT 15K) Glycol 34%	328	275	357	288	497	417	540	437	674	564	731	589	817	685
Fluido refrigerante	m³/h Portata Flowrate		61,4	51,4	66,7	53,9	93,0	77,9	101,0	81,6	125,9	105,5	136,7	110,1	152,8	128,1
Refrigerant fluid	kPa Perdita di carico Pressure drop		34	25	26	18	39	28	34	23	83	59	49	33	23	17
Portata d'aria	Air quantity	m³/h	104400	80800	96000	75600	156600	121200	144000	113400	208800	161600	192000	151200	261000	202000
Assorbimento motori	W		9200	6240	9200	6240	13800	9360	13800	9360	18400	12480	18400	12480	23000	15600
Motor power consumption	A		20,4	11,6	20,4	11,6	30,6	17,4	30,6	17,4	40,8	23,2	40,8	23,2	51	29
Livello pressione sonora	Sound pressure level	dB (A) (total)	59	51	59	51	61	53	61	53	62	54	62	54	63	55
Attacchi	Connections	Ø"	4"	4"	4"	4"	4"	4"	4"	4"	4"	4"	2 x 4"	2 x 4"	2 x 4"	2 x 4"
Modello	Model	EHLDS (2,1 mm)	3226C	3227C	3236B	3237F	3246B	3247B	3256E							
Potenza	Capacity	□ kW (ΔT 15K) Glycol 34%	287	240	307	248	428	359	466	378	580	485	619	501	731	611
Fluido refrigerante	m³/h Portata Flowrate		53,7	44,9	57,4	46,5	80,0	67,1	87,2	70,6	108,4	90,7	115,8	93,7	136,7	114,3
Refrigerant fluid	kPa Perdita di carico Pressure drop		64	46	50	34	30	21	56	38	63	45	51	34	94	68
Portata d'aria	Air quantity	m³/h	84000	66000	80400	62400	126000	99000	120600	93600	168000	132000	160800	124800	210000	165000
Assorbimento motori	W		6560	4480	6560	4480	9840	6720	9840	6720	13120	8960	13120	8960	16400	11200
Motor power consumption	A		14,6	8,4	14,6	8,4	21,9	12,6	21,9	12,6	29,2	16,8	29,2	16,8	36,5	21,0
Livello pressione sonora	Sound pressure level	dB (A) (total)	53	46	53	46	55	48	55	48	56	49	56	49	57	50
Attacchi	Connections	Ø"	2 1/2"	2 1/2"	4"	4"	4"	4"	4"	4"	4"	4"	4"	4"	2 x 4"	2 x 4"
Modello	Model	EHLDX (2,1 mm)	6226C	6227C	6236F	6237F	6246B	6247B	6256E							
Potenza	Capacity	□ kW (ΔT 15K) Glycol 34%	249	196	251	194	377	297	378	291	503	395	505	387	636	502
Fluido refrigerante	m³/h Portata Flowrate		46,6	36,7	46,9	36,2	70,4	55,5	70,6	54,4	93,9	73,8	94,4	72,4	118,7	93,8
Refrigerant fluid	kPa Perdita di carico Pressure drop		51	33	35	22	61	39	39	24	50	32	36	22	76	49
Portata d'aria	Air quantity	m³/h	66000	50000	62800	46800	99000	75000	94200	70200	132000	100000	125600	93600	165000	125000
Assorbimento motori	W		3320	2080	3320	2080	4980	3120	4980	3120	6640	4160	6640	4160	8300	5200
Motor power consumption	A		8,8	4,6	8,8	4,6	13,2	6,9	13,2	6,9	17,6	9,2	17,6	9,2	22	11,5
Livello pressione sonora	Sound pressure level	dB (A) (total)	48	41	48	41	50	43	50	43	51	44	51	44	52	45
Attacchi	Connections	Ø"	2 1/2"	2 1/2"	4"	4"	4"	4"	4"	4"	4"	4"	4"	4"	2 x 4"	2 x 4"
Modello	Model	EHLDT (2,1 mm)	4226C	4227C	4236F	4237F	4246B	4247B	4256E							
Potenza	Capacity	□ kW (ΔT 15K) Glycol 34%	229	189	237	190	348	287	361	288	462	381	479	383	582	479
Fluido refrigerante	m³/h Portata Flowrate		42,7	35,2	44,4	35,4	65,1	53,6	67,4	53,9	86,3	71,1	89,5	71,6	108,9	89,6
Refrigerant fluid	kPa Perdita di carico Pressure drop		42	30	31	20	51	36	35	23	41	29	31	21	62	44
Portata d'aria	Air quantity	m³/h	61600	48400	59200	46000	92400	72600	88800	69000	123200	96800	118400	92000	154000	121000
Assorbimento motori	W		3200	2080	3200	2080	4800	3120	4800	3120	6400	4160	6400	4160	8000	5200
Motor power consumption	A		9,0	4,4	9,0	4,4	13,5	6,6	13,5	6,6	18,0	8,8	18,0	8,8	22,5	11,0
Livello pressione sonora	Sound pressure level	dB (A) (total)	46	41	46	41	48	43	48	43	49	44	49	44	50	45
Attacchi	Connections	Ø"	2 1/2"	2 1/2"	4"	4"	4"	4"	4"	4"	4"	4"	4"	4"	2 x 4"	2 x 4"
DATI COMUNI / COMMON DATA																
Elettroventilatori	Ø 800-900 mm x n°		4 88	4 88	6 888	6 888	8 8888	8 8888	10 88888							
Fans	Collegamento	Connection	△	△	△	△	△	△	△							
Superficie esterna	External surface	m²	700	933	1049	1399	1399	1866	1749							
Superficie interna	Internal surface	m²	45,0	60,0	68,0	90,0	90,0	120,0	113,0							
Volume circuito	Circuit volume	dm³	2 x 91	2 x 109	2 x 118	2 x 145	2 x 144	2 x 181	2 x 171							
Peso	Weight	kg	1064	1166	1533	1685	1881	2083	2233							

Modello	Model	EHLDU (2,1 mm)	7225C	7226D	7235F	7236C	7245B	7246F	7255E							
Potenza	Capacity	□ kW (ΔT 15K) Glycol 34%	159	134	167	136	242	204	259	203	321	271	345	271	404	341
Fluido refrigerante	m³/h Portata Flowrate		29,7	25,1	31,2	25,3	45,2	38,2	48,4	38	60	50,6	64,6	50,7	75,6	63,9
Refrigerant fluid	kPa Perdita di carico Pressure drop		50	37	66	45	59	44	70	46	51	37	63	42	69	51
Portata d'aria	Air quantity	m³/h	44000	34400	40800	32400	66000	51600	61200	48600	88000	68800	81600	64800	110000	86000
Assorbimento motori	W		1080	680	1080	680	1620	1020	1620	1020	2160	1360	2160	1360	2700	1700
Motor power consumption	A		3,2	1,6	3,2	1,6	4,8	2,4	4,8	2,4	6,4	3,2	6,4	3,2	8	4
Livello pressione sonora	Sound pressure level	dB (A) (total)	37	31	37	31	39	33	39	33	40	34	40	34	41	35
Attacchi	Connections	Ø"	2 1/2"	2 1/2"	2 1/2"	2 1/2"	2 1/2"	2 1/2"	2 1/2"	2 1/2"	4"	4"	4"	4"	2 x 2 1/2"	2 x 2 1/2"
DATI COMUNI / COMMON DATA																
Elettroventilatori	Ø 900 mm x n°		4 88	4 88	6 888	6 888	8 8888	8 8888	10 88888							
Fans	Collegamento	Connection	△	△	△	△	△	△	△							
Superficie esterna	External surface	m²	466	700	700	1049	933	1399	1166							
Superficie interna	Internal surface	m²	30,0	45,0	45,0	68,0	60,0	90,0	75,0							
Volume circuito	Circuit volume	dm³	2 x 54	2 x 72	2 x 91	2 x 118	2 x 108	2 x 144	2 x 126							
Peso	Weight	kg	962	1064	1381	1533	1679	1881	1980							

VARIANTI COSTRUTTIVE
CONSTRUCTION VARIANTS



- Potenza con tubi puliti
- Capacity with clean tubes

Attacchi lati opposti: A-F-N
Connections opposite sides: A-F-N

1257A		1266A		1267A		1276A		1277A		1286N		1287N		1296N		1297N	
985	773	1098	898	1209	947	1294	1058	1422	1113	1504	1229	1651	1291	1703	1390	1867	1459
184,3	144,6	205,4	168,0	226,0	177,0	242,0	197,7	265,9	208,1	281,2	229,7	308,8	241,5	318,3	259,8	349,1	272,8
25	16	45	31	40	25	67	46	59	37	82	57	63	40	113	78	87	55
286000	207000	361200	266400	343200	248400	421400	310800	400400	289800	481600	355200	457600	331200	541800	399600	514800	372600
32500	20000	39000	24000	39000	24000	45500	28000	45500	28000	52000	32000	52000	32000	58500	36000	58500	36000
60,0	35,0	72,0	42,0	72,0	42,0	84,0	49,0	84,0	49,0	96,0	56,0	96,0	56,0	108,0	63,0	108,0	63,0
67	60	67	60	67	60	68	61	68	61	68	61	68	61	68	61	68	61
2 x 4"		2 x 4"		2 x 4"		2 x 4"		2 x 4"		3 x 4"		3 x 4"		3 x 4"		3 x 4"	
2257A		2266A		2267A		2276A		2277A		2286N		2287N		2296N		2297N	
890	720	1004	841	1091	881	1182	990	1283	1035	1373	1150	1490	1201	1554	1300	1683	1357
166,4	134,6	187,6	157,2	203,9	164,6	220,9	185,1	239,9	193,5	256,7	215,0	278,5	224,5	290,5	243,1	314,7	253,7
21	14	38	27	33	22	57	41	49	32	69	50	52	35	96	69	72	48
240000	189000	313200	242400	288000	226800	365400	282800	336000	264600	417600	323200	384000	302400	469800	363600	432000	340200
23000	15600	27600	18720	27600	18720	32200	21840	32200	21840	36800	24960	36800	24960	41400	28080	41400	28080
51	29	61,2	34,8	61,2	34,8	71,4	40,6	71,4	40,6	81,6	46,4	81,6	46,4	91,8	52,2	91,8	52,2
63	55	63	55	63	55	64	56	64	56	64	56	64	56	64	56	64	56
2 x 4"		2 x 4"		2 x 4"		2 x 4"		2 x 4"		3 x 4"		3 x 4"		3 x 4"		3 x 4"	
3257E		3266A		3267A		3276A		3277A		3286A		3287A		3296A		3297A	
780	631	856	717	917	743	1017	852	1087	881	1181	989	1262	1022	1336	1117	1426	1154
145,8	117,9	160,0	134,1	171,4	138,9	190,2	159,2	203,3	164,9	220,9	184,9	235,9	191,0	249,7	208,9	266,5	215,7
66	45	28	20	24	16	43	31	36	24	62	44	50	34	84	61	68	46
201000	156000	252000	198000	241200	187200	294000	231000	281400	218400	336000	264000	321600	249600	378000	297000	361800	280800
16400	11200	19680	13440	19680	13440	22960	15680	22960	15680	26240	17920	26240	17920	29520	20160	29520	20160
36,5	21,0	43,8	25,2	43,8	25,2	51,1	29,4	51,1	29,4	58,4	33,6	58,4	33,6	65,7	37,8	65,7	37,8
57	50	57	50	57	50	58	51	58	51	58	51	58	51	58	51	58	51
2 x 4"		2 x 4"		2 x 4"		2 x 4"		2 x 4"		2 x 4"		2 x 4"		2 x 4"		2 x 4"	
6257E		6266A		6267E		6276A		6277A		6286A		6287A		6296A		6297A	
637	486	749	591	760	585	880	699	882	674	1037	802	1030	773	1170	909	1161	873
119	90,9	139,8	110,4	142,1	109,3	164,2	130,5	164,9	126	193	149,7	192,5	144,5	217,8	169,7	216,9	163,2
47	29	23	15	75	47	34	22	25	15	51	32	36	21	69	44	49	29
157000	117000	198000	150000	188400	140400	231000	175000	219800	163800	264000	200000	251200	187200	297000	225000	282600	210600
8300	5200	9960	6240	9960	6240	11620	7280	11620	7280	13280	8320	13280	8320	14940	9360	14940	9360
22	11,5	26,4	13,8	26,4	13,8	30,8	16,1	30,8	16,1	35,2	18,4	35,2	18,4	39,6	20,7	39,6	20,7
52	45	52	45	52	45	53	46	53	46	53	46	53	46	53	46	53	46
2 x 4"		2 x 4"		2 x 4"		2 x 4"		2 x 4"		2 x 4"		2 x 4"		2 x 4"		2 x 4"	
4257E		4266A		4267E		4276A		4277A		4286A		4287A		4296A		4297A	
602	481	683	564	726	579	803	662	834	667	932	768	967	773	1064	876	1102	880
112,6	90,0	127,7	105,4	135,7	108,3	150,2	123,9	155,9	124,7	174,3	143,6	180,8	144,5	198,9	163,9	206,1	164,6
41	27	19	13	67	45	28	20	22	14	40	28	31	20	55	39	42	28
148000	115000	184800	145200	177600	138000	215600	169400	207200	161000	246400	193600	236800	184000	277200	217800	266400	207000
8000	5200	9600	6240	9600	6240	11200	7280	11200	7280	12800	8320	12800	8320	14400	9360	14400	9360
22,5	11,0	27,0	13,2	27,0	13,2	31,5	15,4	31,5	15,4	36,0	17,6	36,0	17,6	40,5	19,8	40,5	19,8
50	45	50	45	50	45	51	46	51	46	51	46	51	46	51	46	51	46
2 x 4"		2 x 4"		2 x 4"		2 x 4"		2 x 4"		2 x 4"		2 x 4"		2 x 4"		2 x 4"	
10		12		12		14		14		16		16		18		18	
△	△	△	△	△	△	△	△	△	△	△	△	△	△	△	△	△	△
2332	2099	2798	2449	3265	2798	3731	3148	4197	211,0	181,0	241,0	203,0	271,0	210,0	181,0	241,0	
150,0	135,0	185,0	158,0	211,0	181,0	241,0	203,0	271,0	2 x 216	2 x 198	2 x 252	2 x 225	2 x 287	2 x 251	2 x 323	2 x 278	
2486	2588	2892	2946	3300	3294	3698	3649	4103									
7256B		7265A		7266B		7275A		7276E		7285A		7286A		7295N		7296A	
432	338	478	405	518	406	563	476	606	475	654	552	690	537	739	624	775	606
80,8	63,1	89,5	75,7	96,9	76	105,2	88,9	113,3	88,9	122,2	103,2	129	100,4	138,1	116,6	145	113,3
43	28	24	17	68	45	35	26	90	60	50	37	23	15	52	38	31	21
102000	81000	132000	103200	122400	97200	154000	120400	142800	113400	176000	137600	163200	129600	198000	154800	183600	145800
2700	1700	3240	2040	3240	2040	3780	2380	3780	2380	4320	2720	4320	2720	4860	3060	4860	3060
8	4	9,6	4,8	9,6	4,8	11,2	5,6	11,2	5,6	12,8	6,4	12,8	6,4	14,4	7,2	14,4	7,2
41	35	41	35	41	35	42	36	42	36	42	36	42	36	42	36	42	36
4"		2 x 2 1/2"		4"		2 x 2 1/2"		2 x 4"		2 x 2 1/2"		2 x 4"		2 x 4"		2 x 4"	
10		12		12		14		14		16		16		18		18	
△	△	△	△	△	△	△	△	△	△	△	△	△	△	△	△	△	△
1749	1399	2099	1632	2449	1866	2798	2099	3148	113,0	90,0	135,0	105,0	158,0	120,0	181,0	135,0	
2 x 171	2 x 144	2 x 198	2 x 162	2 x 225	2 x 180	2 x 251	2 x 197	2 x 278	2233	2284	2588	2592	2946	2890	3294	3195	
2233	2284	2588	2592	2946	2890	3294	3195	3649									

Ventilatori Ventilateurs	Fans Ventiladores	Вентиляторы Wentylatory	n°	4	6	8	10	12	14	16	18
A	mm		2844	4266	5688	7110	8532	9954	11376	12798	
B	mm		1422	1422	1422	1422	1422	2844	2844	2844	
C	mm		---	1422	2844	4266	5688	4266	5688	7110	

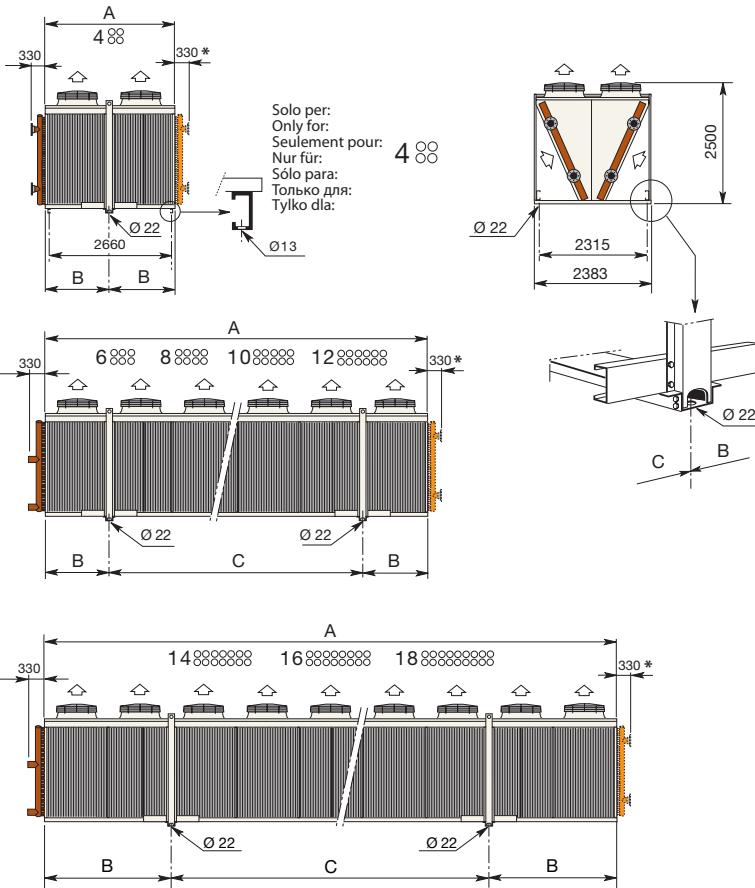

Circuiti - Circuits - Circuits - Kreisläufe
Circuitos - Контур - Obieg

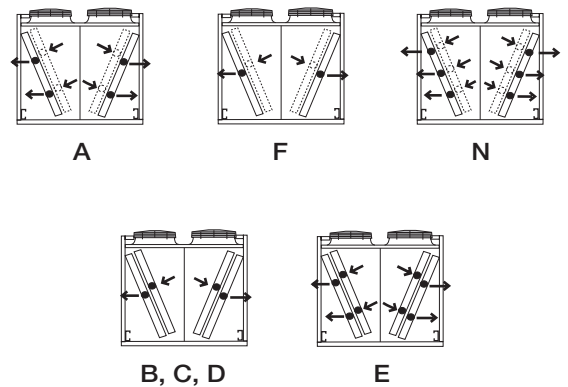

Posizione attacchi

Circuiti: **A, F, N** lati opposti (*)
Circuiti: **B, C, D, E** stesso lato

Connection position

Circuit: **A, F, N** opposite sides (*)
Circuits: **B, C, D, E** same side

Position des connexions

Circuits: **A, F, N** côtés opposés (*)
Circuits: **B, C, D, E** même côté

Lage der Anschlüsse

Kreisläufe: **A, F, N** Zweiseitig (*)
Kreisläufe: **B, C, D, E** Einseitig

Posición de las conexiones

Circuitos: **A, F, N** Lados opuestos (*)
Circuitos: **B, C, D, E** mismo lado

Соединительная позиция

Контур: **A, F, N** Противоположной стороне (*)
Контур: **B, C, D, E** с той же стороны

Położenie przyłączy

Obieg: **A, F, N** Przeciwne strony (*)
Obieg: **B, C, D, E** ta sama strona

Guida distanze / Distances guide / Guide distances / Entfernungen Anleitung
Guía de distancias / Рекомендуемые расстояния
Minimalne odległości montażowe

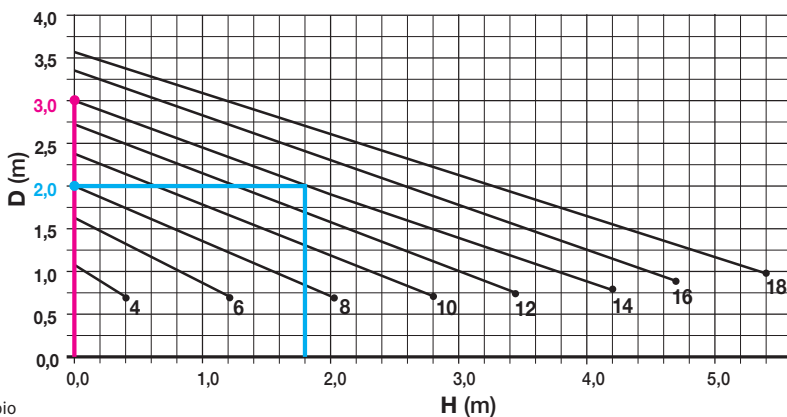

Esempio
Example
Exemple
Beispiel
Ejemplo
Пример
Przykład

n° fans	14	14
H (m)	0,0	1,8
D (m)	3,0	2,0

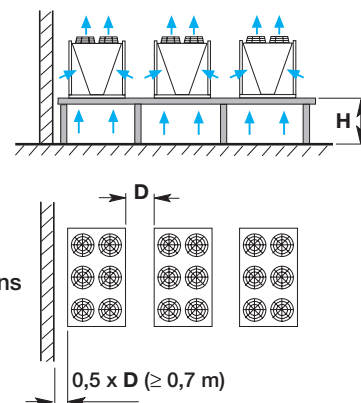

Separatori flusso aria / Section division / Cloisonnement / Ventilatorsektionen
 Separadores flujo de aire / Разделитель воздушного потока / Przegrody wentylatorów

1

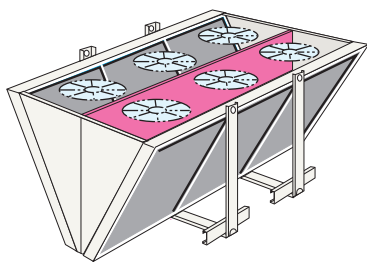

- **VERSIONE STANDARD:** separazione flusso d'aria per file di ventilatori
- **STANDARD VERSION:** fan section division for each fan row
- **VERSION STANDARD:** cloisonnement par rang de ventilateurs
- **STANDARD AUSFÜHRUNG** mit Trennwänden je Ventilatorreihe
- **VERSIÓN STANDARD:** separación flujo de aire para cada fila de ventiladores
- **СТАНДАРТНАЯ ВЕРСИЯ:** разделения воздушных потоков
- **WERSJA STANDARDOWA:** przegroda pomiędzy rzędami wentylatorów

2

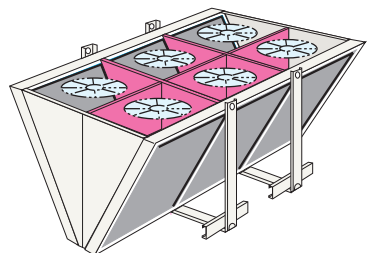

- **VERSIONE SPECIALE:** separatore di flusso d'aria per ogni ventilatore
- **SPECIAL VERSION:** fan section division for each fan
- **VERSIONSPECIAL:** cloisonnement par ventilateur
- **SPEZIALAUSFÜHRUNG** mit Trennwänden zwischen den Ventilatorsektionen je Ventilator
- **VERSION ESPECIAL:** separación por cada ventilador
- **СПЕЦИАЛЬНОЕ ИСПОЛНЕНИЕ:** разделитель воздушного потока для каждого из вентиляторов
- **WERSJE SPECJALNE:** przegrody indywidualne dla każdego wentylatora

Esempio di ordinazione
 Ordering example
 Exemple de commande
 Typenschlüssel
 Ejemplo de pedido
 Пример заказа
 Nomenclatura

EHL D 1 N 2237 B

<p>E = Extra</p> <p>H = Hitec®</p> <p>L = Fluido refrigerante Refrigerant fluid Fluid caloporteur Kälteträger Enfriadores de líquido Хладагент Czynnik chłodzony</p> <p>D = Batteria doppia Twin coil Batterie double Doppelbatterie Doble batería Двойная батарея Podwójny wymiennik</p>	<p>Separatori flusso aria Section division Cloisonnement Ventilatorsektionen Separadores flujo de aire Разделитель воздушного потока Przegrody wentylatorów</p> <p>1 = </p> <p>2 = </p>	<p>F N = Normale Normal Normal Normal Normal Normalny Normalny</p> <p>S X T = Silenzioso Quiet Silencieux Leise Silencioso Бесшумный Cichy</p> <p>U = Residenziale Residential Résidentiel Sehr Leise Residencial Очень бесшумный Bardzo cichy</p>	<p>Codice Code Code Kode Código Код Kod</p>	<p>Circuito Circuit Circuit Kreisläufe Circuitos Контур Obieg</p>
---	---	---	---	---

Selezione

È disponibile un programma di selezione degli apparecchi operante in ambiente Windows (REFRIGER®).

Selection

A Windows software programme is available for unit selection (REFRIGER®).

Sélection

Un programme de calcul pour effectuer la sélection des aéro-réfrigérant sous Windows est disponible (REFRIGER®).

Auswahl

Für die Auslegung der Leistung ist ein Windows Computerprogramm erhältlich (REFRIGER®).



Selección

Está disponible un programa de selección de equipos operando bajo entorno Windows (REFRIGER®).

Подбор

Программное обеспечение Windows для оперативного выбора (REFRIGER®).

Dobór

Dostępny jest program doborowy pracujący w środowisku Windows służący do doboru urządzeń (REFRIGER®).

**Livello pressione sonora / Sound pressure level / Niveau pression sonore / Schalldruckpegel
Nivel de presión sonora / Уровень звуковой мощности / Poziom mocy akustycznej**

Livello pressione sonora sulla superficie del parallelepipedo indicato, con piano riflettente.

Sound pressure level on the indicated parallelepiped surface, with reflective plane.

Niveau pression sonore sur la surface du parallelepéde indiqué, avec plan réfléchissant.

Schalldruckpegel auf die gezeigte quaderförmige Hüllfläche, mit reflektierender Ebene.

Nivel de presión sonora sobre las superficies del paralelepédo indicadas, con plano reflectante.

Уровень звукового давления на поверхности указанного параллелипипеда с отражающими плоскостями.

Poziom ciśnienia akustycznego na powierzchni prostopadłościanu, z dolną płaszczyzną odbijającą.

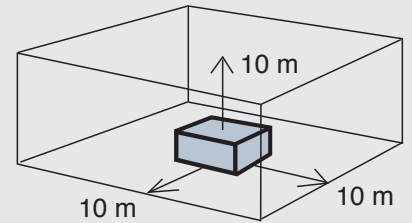

**Livello potenza sonora / Sound power level / Niveau puissance sonore / Schalleistungspegel
Nivel de potencia sonora / Уровень звуковой мощности / Poziom mocy akustycznej**

Livello potenza sonora riferita ad un ventilatore

Single fan sound power level

Niveau puissance sonore se réfère à un seul ventilateur

Schalleistungspegel für einen Ventilator

Nivel de potencia sonora para un solo ventilador

Уровень звуковой мощности для одного вентилятора

Poziom mocy akustycznej odnosi się do jednego wentylatora

Elettroventilatori Electroventiladores		Fans Вентиляторы		Ventilateurs Wentylatory		Ventilatoren		Ø 800				Ø 900							
Modello Model	Model	Modèle	Modell	Modelo	Модель	EHLDS		EHLDT		EHLDF		EHLDN		EHLDX		EHLDU			
Poli Подключение	Poles	Pôles Pola	Polig	Polos		6P		8P		6P		6P		8P		12P			
Collegamento Подключение	Connection Połączenie	Connexion	Anschluß	Conexión		△	∩	△	∩	△	∩	△	∩	△	∩	△	∩		
						dB(A)	Tot.	79	72	72	67	89	82	85	77	74	67	63	57
						dB(A)	63Hz	53	51	50	46	54	55	60	47	58	44	37	29
						dB(A)	125Hz	59	52	52	51	68	58	64	57	59	52	52	44
						dB(A)	250Hz	68	60	61	55	80	65	72	63	64	57	52	46
						dB(A)	500Hz	73	65	66	62	81	75	79	72	69	61	57	52
						dB(A)	1kHz	76	68	68	63	83	77	81	74	69	62	59	53
						dB(A)	2kHz	73	66	65	59	84	77	79	70	67	61	56	49
						dB(A)	4kHz	66	58	58	53	81	73	73	64	59	55	50	41
						dB(A)	8kHz	61	53	54	48	75	63	67	59	54	46	40	34

Dati elettrici di targa dei ventilatori 400V-3PH-50Hz

Questi dati, cui vanno aggiunte le tolleranze di norma, rappresentano i valori massimi di assorbimento nelle condizioni di esercizio più gravose e rappresentano i riferimenti per l'abbinamento di componenti elettrici non forniti da LU-VE.

Capacity plate of 400V-3PH-50Hz fans

These data, to which the standard allowances have to be added, are the maximum absorption values under the hardest operation conditions and serve as references to couple the electrical components which are not supplied by LU-VE.

Informations électriques indiquées sur la plaque des ventilateurs: 400V-3PH-50Hz

Ces données, auxquelles seront ajoutées les tolérances de la norme, représentent les valeurs maximales d'absorption dans les conditions de fonctionnement les plus difficiles et servent de référence pour le couplage des composants électriques non fournis par LU-VE.

Elektrische Daten auf dem Typenschild der Ventilatoren 400V-3PH-50Hz

Diesen Daten sind die Normtolleranzen hinzuzufügen. Sie stellen die max. Aufnahmewerte bei extremen Betriebsbedingungen dar und dienen als Bezug für die Gruppierung mit Bezug für die Gruppierung mit Komponenten.

	Ø 800				Ø 900							
	EHLDS		EHLDT		EHLDF		EHLDN		EHLDX		EHLDU	
	6P		8P		6P		6P		8P		12P	
	△	∩	△	∩	△	∩	△	∩	△	∩	△	∩
W	2000	1270	980	570	3300	1900	2450	1560	1110	680	310	190
A	4,30	2,50	2,41	1,21	6,30	3,50	5,20	2,90	2,70	1,36	0,83	0,39

Correzione livello pressione sonora per distanza diversa da 10 m.

Sound pressure level correction for other than 10 m.

Correction niveau pression sonore pour distance différent de 10 m.

Pegeländerung für andere Entfernungen als 10 m.

Corrección de presión Sonora para distancias diferentes de 10 m.

Уровень звукового давления на расстоянии 10 м.

Współczynniki korekcyjne ciśnienia akustycznego dla odległości innej niż 10 m.

EHLD Ø 800 - 900

m	2	3	5	10	15	20	30	40	60	80	100
dB (A)	10	8	5	0	-3	-5,5	-8,5	-11	-14	-16	-18

Aumento del livello potenza sonora in funzione del numero dei ventilatori.

Sound power level increasing according to fan number.

Augmentation du niveau puissance sonore selon le nombre des ventilateurs.

Schalleistungspegel in Abhängigkeit von der Ventilatoranzahl.

El nivel de potencia sonora aumenta en función del número de ventiladores.

Увеличение уровня звуковой мощности в зависимости от количества вентиляторов.

Wzrost poziomu mocy akustycznej w zależności od ilości wentylatorów.

EHLD Ø 800 - 900

Ø N°	4	6	8	10	12	14	16	18
dB (A)	+6	+8	+9	+10	+11	+12	+12	+13

I livelli di potenza sonora sono stati provati secondo la norma EN 13487.

Sound power levels are tested according to EN 13487.

Les niveaux de puissance acoustique sont éprouvés selon la norme EN 13487.

Die Schalleistungspegel sind nach EN 13487 Norm geprüft.

Nivel de potencia Sonora comprobado de acuerdo con la norma EN 13487.

Уровни звуковой мощности проверены согласно нормативам EN 13487.

Pomiary poziomu mocy akustycznej zostały wykonane według normy EN 13487.



Datos de placa ventiladores de 400-3ph-50Hz

Estos datos deben sumarse a los valores indicados como standard, y son los valores máximos de consumo bajo las condiciones más agresivas, y sirven como referencia para calcular las otras componentes eléctricas que no sean suministradas por LU-VE.

Характеристики с этикетки двигателей 400V- 3PH- 50HZ

эти данные, принимают в расчёт нормативный запас отклонения, указывают макс. значения энерг. расхода при самых тяжёлых условиях работы и являются ссылкой для подбора электрических компонентов не поставляемых фирмой LU-VE.

Dane elektryczne dla wentylatorów 400V-3F-50Hz

Aby uzyskać wartości maksymalne poboru mocy, należy do poniższych wartości, dodać wyspecyfikowane w normach wskaźniki tolerancji. Wartości maksymalne występują w szczególnie trudnych warunkach pracy po zastosowaniu komponentów nie występujących w produktach LU-VE.

TWIN COIL DRY COOLERS



SAFETUBES SYSTEM[®] tube protection system



SMART[®] innovative structure system

- "V" shape configuration
- Highest capacity
- Small footprint



(Dry cooler with accessories)

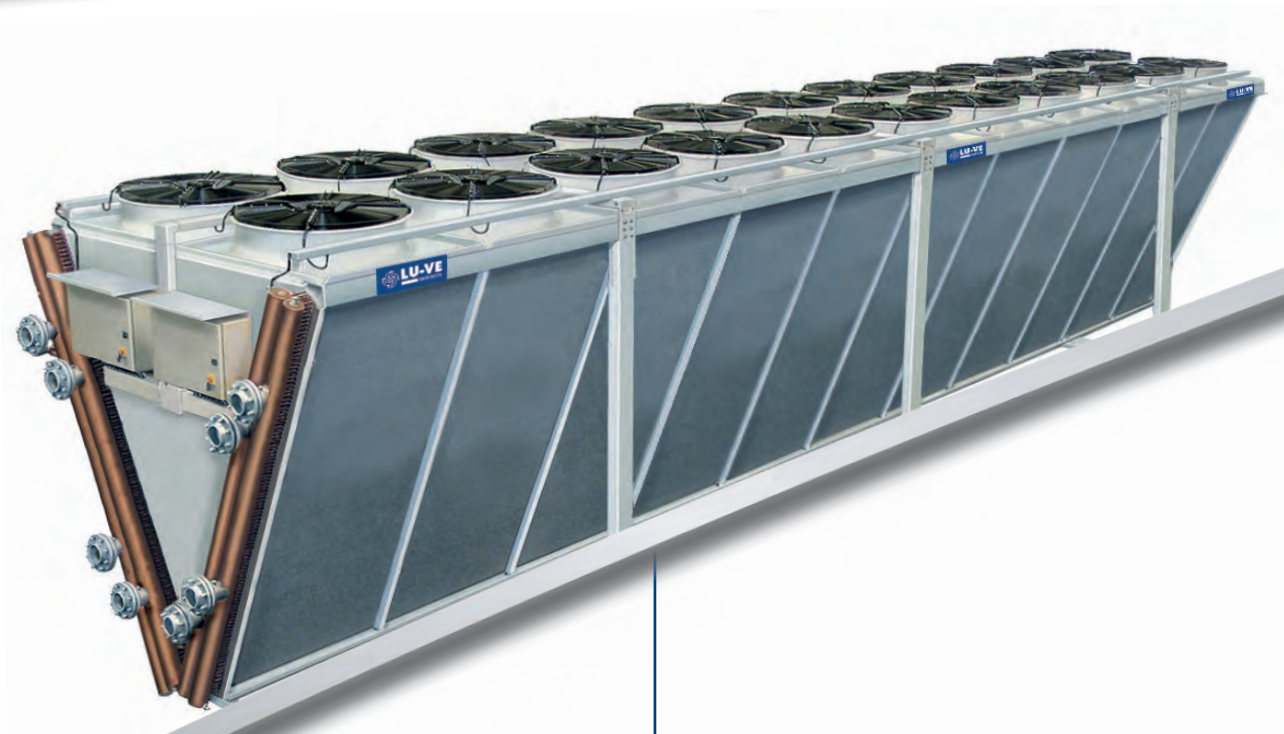

● **XXLD** *Mega Giants*

347 - 2333 kW - 56 models

347 - 2333 kW

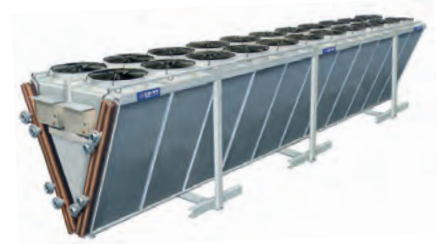

Modello	Model	XXLDF (2,1 mm)	9083B	9084B	9103E	9104E	9123A	9124A	9143A							
Potenza	Capacity	□ kW (ΔT 15K) Glycol 34%	725	593	798	624	927	757	1018	795	1075	880	1185	929	1281	1048
Fluido refrigerante		m ³ /h Portata Flowrate	135,7	110,9	149,1	116,8	173,4	141,5	190,3	148,7	201,0	164,5	221,5	173,7	239,6	196,0
Refrigerant fluid		kPa Perdita di carico Pressure drop	64	44	61	38	84	58	63	40	30	20	29	18	44	30
Portata aria	Air quantity	m ³ /h	242400	178400	229600	166400	303000	223000	287000	208000	363600	267600	344400	249600	424200	312200
Assorbimento motori		W	26000	16000	26000	16000	32500	20000	32500	20000	39000	24000	39000	24000	45500	28000
Motor power consumption	6P	A	48,0	28,0	48,0	28,0	60,0	35,0	60,0	35,0	72,0	42,0	72,0	42,0	84,0	49,0
Livello Pressione sonora	Sound pressure level	dB (A) (total)	66	59	66	59	67	60	67	60	67	60	67	60	68	61
Attacchi	Connections	Ø"	1 x 4"		1 x 4"		2 x 4"		2 x 4"		2 x 4"		2 x 4"		2 x 4"	
Modello	Model	XXLDN (2,1 mm)	9085B	9086B	9105E	9106E	9125A	9126A	9145A							
Potenza	Capacity	□ kW (ΔT 15K) Glycol 34%	663	555	721	582	847	709	919	741	983	824	1072	866	1171	982
Fluido refrigerante		m ³ /h Portata Flowrate	124,0	103,8	134,7	108,8	158,4	132,5	171,8	138,5	183,7	154,1	200,3	162,0	219,0	183,5
Refrigerant fluid		kPa Perdita di carico Pressure drop	54	39	50	33	71	51	52	35	25	18	24	16	37	27
Portata aria	Air quantity	m ³ /h	200000	154400	190000	144000	250000	193000	237500	180000	300000	231600	285000	216000	350000	270200
Assorbimento motori		W	18400	12480	18400	12480	23000	15600	23000	15600	27600	18720	27600	18720	32200	21840
Motor power consumption	6P	A	40,8	23,2	40,8	23,2	51	29	51	29	61,2	34,8	61,2	34,8	71,4	40,6
Livello Pressione sonora	Sound pressure level	dB (A) (total)	62	54	62	54	63	55	63	55	63	55	63	55	64	56
Attacchi	Connections	Ø"	1 x 4"		1 x 4"		2 x 4"		2 x 4"		2 x 4"		2 x 4"		2 x 4"	
Modello	Model	XXL DX (2,1 mm)	9087B	9088F	9107B	9108B	9127B	9128B	9147A							
Potenza	Capacity	□ kW (ΔT 15K) Glycol 34%	493	390	513	386	631	491	641	481	764	597	771	579	873	696
Fluido refrigerante		m ³ /h Portata Flowrate	92,1	72,9	95,9	72,1	117,7	91,8	119,8	89,9	142,5	111,5	144	108,2	162,7	130,1
Refrigerant fluid		kPa Perdita di carico Pressure drop	34	22	56	33	61	39	49	28	98	62	75	44	24	16
Portata aria	Air quantity	m ³ /h	132000	100000	124800	92800	165000	125000	156000	116000	198000	150000	187200	139200	231000	175000
Assorbimento motori		W	6600	4200	6600	4200	8250	5250	8250	5250	9900	6300	9900	6300	11550	7350
Motor power consumption	8P	A	17,6	8,8	17,6	8,8	22	11	22	11	26,4	13,2	26,4	13,2	30,8	15,4
Livello Pressione sonora	Sound pressure level	dB (A) (total)	51	44	51	44	52	45	52	45	52	45	52	45	53	46
Attacchi	Connections	Ø"	1 x 4"		1 x 4"		1 x 4"		1 x 4"		1 x 4"		1 x 4"		2 x 4"	
Modello	Model	XXL DU (2,1 mm)	9089F		9109F		9129B		9149B							
Potenza	Capacity	□ kW (ΔT 15K) Glycol 34%	347	282			440	354		526	423			621	495	
Fluido refrigerante		m ³ /h Portata Flowrate	64,9	52,7			82,4	66,2		98,3	79,1			116,1	92,6	
Refrigerant fluid		kPa Perdita di carico Pressure drop	58	39			77	52		49	33			75	49	
Portata aria	Air quantity	m ³ /h	84800	66400			106000	83000		127200	99600			148400	116200	
Assorbimento motori		W	2160	1360			2700	1700		3240	2040			3780	2380	
Motor power consumption	12P	A	6,4	3,2			8	4		9,6	4,8			11,2	5,6	
Livello Pressione sonora	Sound pressure level	dB (A) (total)	40	34			41	35		41	35			42	36	
Attacchi	Connections	Ø"	1 x 4"				1 x 4"			1 x 4"				1 x 4"		
DATI COMUNICOMMON DATA																
Elettroventilatori		Ø 900 mm x n°	8	8	10	10	12	12	14							
Fans		Collegamento Connection	△	△	△	△	△	△	△							
Superficie Esterna	TURBOCOIL External Surface	m ²	1380	1839	1724	2299	2069	2759	2414							
Superficie Interna	Internal Surface	m ²	89	119	111	148	133	178	156							
Volume circuito		dm ³	2 x 151	2 x 187	2 x 177	2 x 222	2 x 204	2 x 257	2 x 230							
Peso	Weight	kg	1870	2070	2170	2420	2520	2770	2880							

VARIANTI COSTRUTTIVE
CONSTRUCTION VARIANTS



- Potenza con tubi puliti
- Capacity with clean tubes

Attacchi lati opposti: A-F-N
Connections opposite sides: A-F-N



9144A		9163N		9164N		9183N		9184N		9203N		9204N		9223N		9224N	
1411	1105	1478	1208	1625	1272	1691	1381	1857	1452	1907	1556	2093	1636	2127	1736	2333	1822
263,8	206,6	276,3	225,9	303,9	237,9	316,1	258,1	347,2	271,5	356,4	291,0	391,3	305,9	397,7	324,5	436,2	340,7
43	27	48	33	39	25	66	45	53	34	87	60	70	44	112	78	90	57
401800	291200	484800	356800	459200	332800	545400	401400	516600	374400	606000	446000	574000	416000	666600	490600	631400	457600
45500	28000	52000	32000	52000	32000	58500	36000	58500	36000	65000	40000	65000	40000	71500	44000	71500	44000
84,0	49,0	96,0	56,0	96,0	56,0	108,0	63,0	108,0	63,0	120,0	70,0	120,0	70,0	132,0	77,0	132,0	77,0
68	61	68	61	68	61	69	62	69	62	69	62	69	62	70	63	70	63
2 x 4"		3 x 4"		3 x 4"		3 x 4"		3 x 4"		3 x 4"		3 x 4"		3 x 4"		3 x 4"	
9146A		9165N		9166N		9185N		9186N		9205N		9206N		9225N		9226N	
1275	1030	1351	1131	1468	1185	1544	1293	1677	1353	1741	1457	1889	1523	1941	1625	2105	1696
238,4	192,5	252,6	211,4	274,5	221,5	288,7	241,7	313,5	252,9	325,5	272,4	353,3	284,8	363,0	303,7	393,6	317,1
35	23	40	29	32	22	55	40	44	30	74	53	58	39	95	69	74	50
332500	252000	400000	308800	380000	288000	450000	347400	427500	324000	500000	386000	475000	360000	550000	424600	522500	396000
32200	21840	36800	24960	36800	24960	41400	28080	41400	28080	46000	31200	46000	31200	50600	34320	50600	34320
71,4	40,6	81,6	46,4	81,6	46,4	91,8	52,2	91,8	52,2	102	58	102	58	112,2	63,8	112,2	63,8
64	56	64	56	64	56	65	57	65	57	65	57	65	57	66	58	66	58
2 x 4"		3 x 4"		3 x 4"		3 x 4"		3 x 4"		3 x 4"		3 x 4"		3 x 4"		3 x 4"	
9148E		9167A		9168E		9187A		9188A		9207A		9208A		9227A		9228A	
910	678	1012	785	1043	776	1145	890	1161	862	1291	992	1299	961	1431	1101	1436	1060
170	126,7	188,6	146,7	194,7	145,1	213,4	166,3	216,7	161,2	240,2	185,3	242,5	179,6	266,2	205,6	268	198,2
75	44	35	21	107	62	47	29	37	21	62	38	49	27	80	49	62	35
218400	162400	264000	200000	249600	185600	297000	225000	280800	208800	330000	250000	312000	232000	363000	275000	343200	255200
11550	7350	13200	8400	13200	8400	14850	9450	14850	9450	16500	10500	16500	10500	18150	11550	18150	11550
30,8	15,4	35,2	17,6	35,2	17,6	39,6	19,8	39,6	19,8	44	22	44	22	48,4	24,2	48,4	24,2
53	46	53	46	53	46	54	47	54	47	54	47	54	47	55	48	55	48
2 x 4"		2 x 4"		2 x 4"		2 x 4"		2 x 4"		2 x 4"		2 x 4"		2 x 4"		2 x 4"	
9169B				9189A				9209A				9229A					
		712 572				796 636				896 708				997 781			
		133,1 107,1				148,8 118,8				167,5 132,4				186,5 146,1			
		106 71				24 16				32 21				41 26			
		169600 132800				190800 149400				212000 166000				233200 182600			
		4320 2720				4860 3060				5400 3400				5940 3740			
		12,8 6,4				14,4 7,2				16 8				17,6 8,8			
		42 36				43 37				43 37				44 38			
		1 x 4"				2 x 4"				2 x 4"				2 x 4"			
14		16		16		18		18		20		20		22		22	
△		△		△		△		△		△		△		△		△	
3219		2759		3679		3104		4139		3449		4599		3794		5058	
208		178		237		200		267		223		297		245		326	
2 x 292		2 x 256		2 x 327		2 x 283		2 x 362		2 x 309		2 x 397		2 x 335		2 x 433	
3280		3230		3580		3510		3930		3980		4430		4280		4780	

Ventilatori Fans Ventiladores Вентиляторы Ventilateurs Ventilatoren Wentylatory	n°	8	10	12	14	16	18	20	22
A	mm	4656	5820	6984	8148	9312	10476	11640	12804
B	mm	2328	3492	4656	3492	4656	5820	3492	4656
C	mm	---	---	---	---	---	---	3492	3492

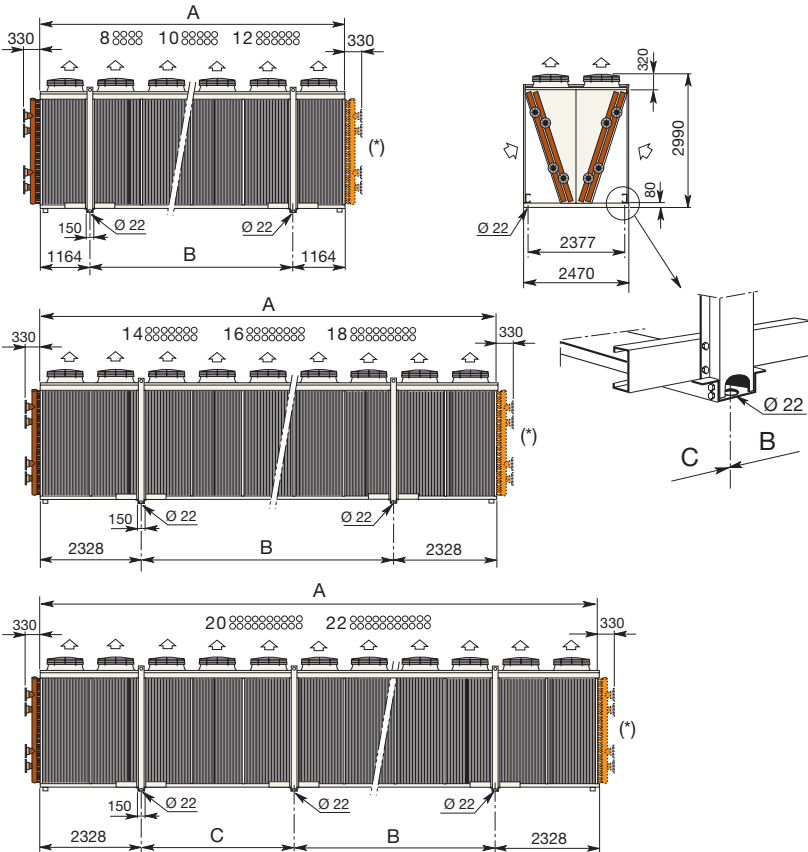

Circuiti - Circuits - Circuits - Kreisläufe
Circuitos - Контур - Obieg

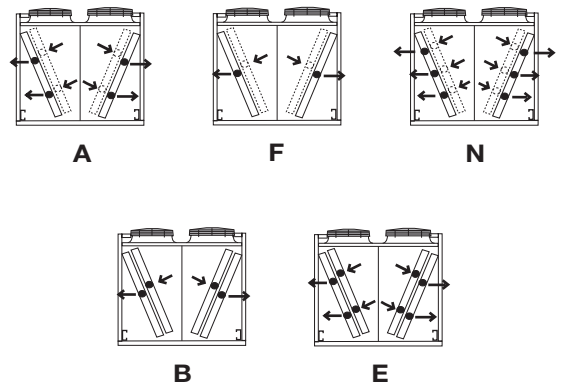

Posizione attacchi

Circuiti: **A, F, N** lati opposti (*)
Circuiti: **B, E** stesso lato

Connection position

Circuit: **A, F, N** opposite sides (*)
Circuits: **B, E** same side

Position des connexions

Circuit: **A, F, N** côtés opposés (*)
Circuits: **B, E** même côté

Lage der Anschlüsse

Kreisläufe: **A, F, N** Zweiseitig (*)
Kreisläufe: **B, E** Einseitig

Posición de las conexiones

Circuitos: **A, F, N** Lados opuestos (*)
Circuitos: **B, E** mismo lado

Соединительная позиция

Контур: **A, F, N** Противоположной стороне (*)
Контур: **B, E** с той же стороны

Położenie przyłączy

Obieg: **A, F, N** Przeciwne strony (*)
Obieg: **B, E** ta sama strona

Guida distanze / Distances guide / Guide distances / Entfernungen Anleitung
Guía de distancias / Рекомендуемые расстояния
Minimalne odległości montażowe

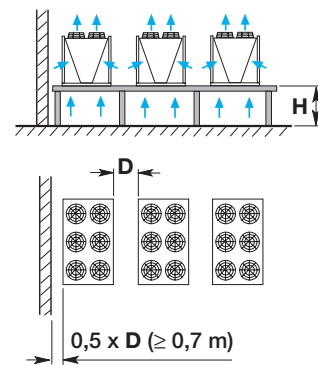
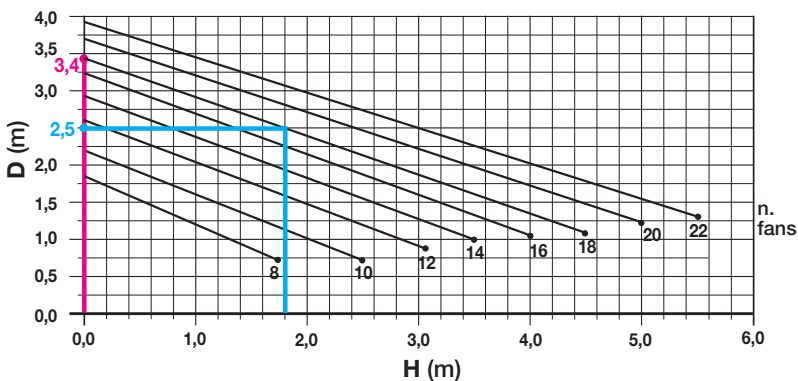

Esempio
Example
Exemple
Beispiel
Ejemplo
Пример
Przykład

n° fans	18	18
H (m)	0,0	1,8
D (m)	3,4	2,5

1

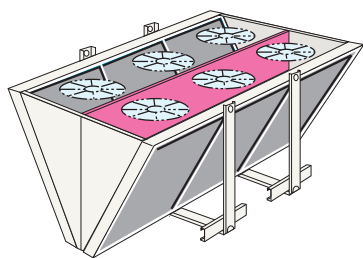

- **VERSIONE STANDARD:** separazione flusso d'aria per file di ventilatori
- **STANDARD VERSION:** fan section division for each fan row
- **VERSION STANDARD:** cloisonnement par rang de ventilateurs
- **STANDARD AUSFÜHRUNG** mit Trennwänden je Ventilatorreihe
- **VERSION STANDARD:** separación flujo de aire para cada fila de ventiladores
- **СТАНДАРТНАЯ ВЕРСИЯ:** разделения воздушных потоков
- **WERSJA STANDARDOWA:** przegroda pomi ędzy rz ędami wentylatorów

2

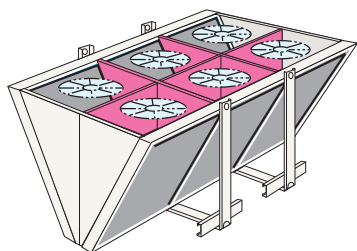

- **VERSIONE SPECIALE:** separatore di flusso d'aria per ogni ventilatore
- **SPECIAL VERSION:** fan section division for each fan
- **VERSIONSPECIAL:** cloisonnement par ventilateur
- **SPEZIALAUSFÜHRUNG** mit Trennwänden zwischen den Ventilatorsektionen je Ventilator
- **VERSION ESPECIAL:** separación por cada ventilador
- **СПЕЦИАЛЬНОЕ ИСПОЛНЕНИЕ:** разделитель воздушного потока для каждого из вентиляторов
- **WERSJE SPECJALNE:** przegrody indywidualne dla ka żdego wentylatora

Esempio di ordinazione
Ordering example
Exemple de commande
Typenschlüssel
Ejemplo de pedido
Пример заказа
Nomenklatura

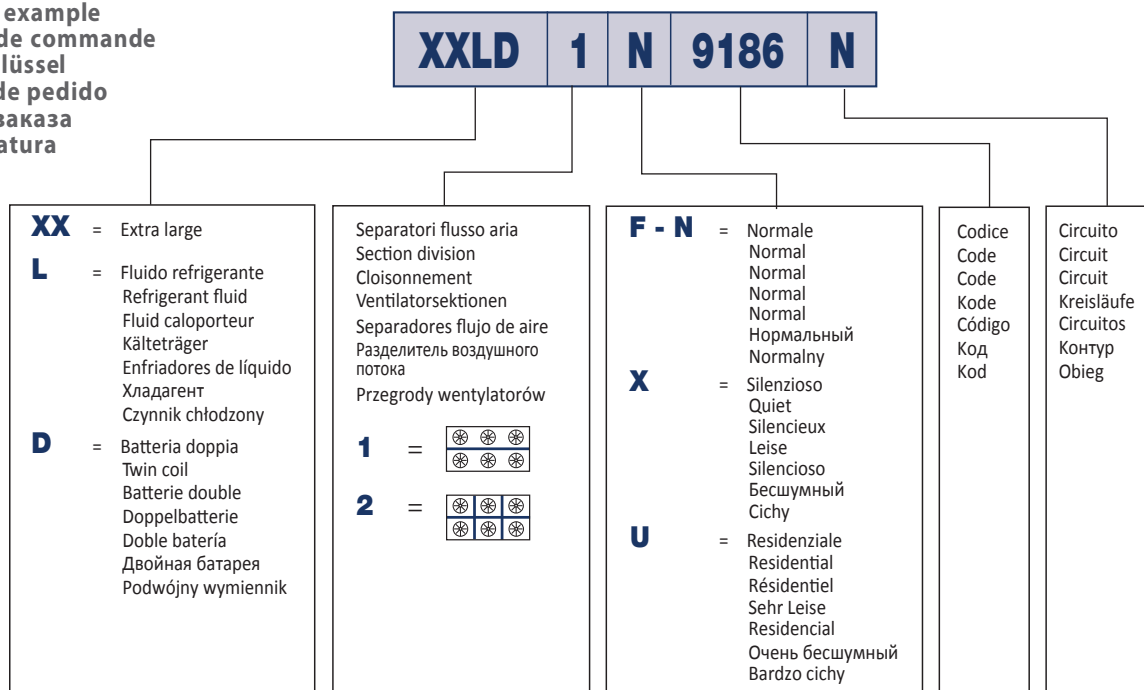

Selezione

È disponibile un programma di selezione degli apparecchi operante in ambiente Windows (REFRIGER®).

Selection

A Windows software programme is available for unit selection (REFRIGER®).

Sélection

Un programme de calcul pour effectuer la sélection des aéro-réfrigérant sous Windows est disponible (REFRIGER®).

Auswahl

Für die Auslegung der Leistung ist ein Windows Computerprogramm erhältlich (REFRIGER®).



Selección

Está disponible un programa de selección de equipos operando bajo entorno Windows (REFRIGER®).

Подбор

Программное обеспечение Windows для оперативного выбора (REFRIGER®).

Dobór

Dostępny jest program doborowy pracujący w środowisku Windows służący do doboru urządzeń (REFRIGER®).

**Livello pressione sonora / Sound pressure level / Niveau pression sonore / Schalldruckpegel
Nivel de presión sonora / Уровень звуковой мощности / Poziom mocy akustycznej**

Livello pressione sonora sulla superficie del parallelepipedo indicato, con piano riflettente.

Sound pressure level on the indicated parallelepiped surface, with reflective plane.

Niveau pression sonore sur la surface du parallelepépede indiqué, avec plan réfléchissant.

Schalldruckpegel auf die gezeigte quaderförmige Hüllfläche, mit reflektierender Ebene.

Nivel de presión sonora sobre las superficies del paralelepépedo indicadas, con plano reflectante.

Уровень звукового давления на поверхности указанного параллелипипеда с отражающими плоскостями.

Poziom ciśnienia akustycznego na powierzchni prostopadłościanu, z dolną płaszczyzną odbijającą.

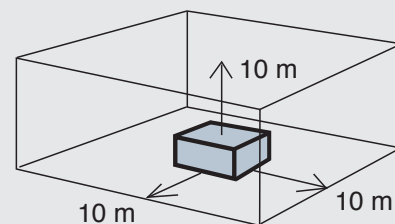

**Livello potenza sonora / Sound power level / Niveau puissance sonore / Schalleistungspegel
Nivel de potencia sonora / Уровень звуковой мощности / Poziom mocy akustycznej**

Livello potenza sonora riferita ad un ventilatore

Single fan sound power level

Niveau puissance sonore se réfère à un seul ventilateur

Schalleistungspegel für einen Ventilator

Nivel de potencia sonora para un solo ventilador

Уровень звуковой мощности для одного вентилятора

Poziom mocy akustycznej odnosi się do jednego wentylatora

Elettroventilatori Electroventiladores Fans Вентиляторы Ventilateurs Ventilatoren						Ø 900								
Modello Model	Model	Modèle	Modell	Modelo	Модель	XXLDF		XXLDN		XXLDX		XXLDU		
Poli Подключение	Poles	Pôles Pola	Polig	Polos	Модель	6P		6P		8P		12P		
Collegamento Подключение	Connection	Connexion	Anschluß	Conexión	Модель	△	∧	△	∧	△	∧	△	∧	
					dB(A)	Tot.	89	82	85	77	74	67	63	57
					dB(A)	63Hz	54	55	60	47	58	44	37	29
					dB(A)	125Hz	68	58	64	57	59	52	52	44
					dB(A)	250Hz	80	65	72	63	64	57	52	46
					dB(A)	500Hz	81	75	79	72	69	61	57	52
					dB(A)	1kHz	83	77	81	74	69	62	59	53
					dB(A)	2kHz	84	77	79	70	67	61	56	49
					dB(A)	4kHz	81	73	73	64	59	55	50	41
					dB(A)	8kHz	75	63	67	59	54	46	40	34

Dati elettrici di targa dei ventilatori 400V-3PH-50Hz

Questi dati, cui vanno aggiunte le tolleranze di norma, rappresentano i valori massimi di assorbimento nelle condizioni di esercizio più gravose e rappresentano i riferimenti per l'abbinamento di componenti elettrici non forniti da LU-VE.

Capacity plate of 400V-3PH-50Hz fans

These data, to which the standard allowances have to be added, are the maximum absorption values under the hardest operation conditions and serve as references to couple the electrical components which are not supplied by LU-VE.

Informations électriques indiquées sur la plaque des ventilateurs: 400V-3PH-50Hz

Ces données, auxquelles seront ajoutées les tolérances de la norme, représentent les valeurs maximales d'absorption dans les conditions de fonctionnement les plus difficiles et servent de référence pour le couplage des composants électriques non fournis par LU-VE.

Elektrische Daten auf dem Typenschild der Ventilatoren 400V-3PH-50Hz

Diesen Daten sind die Normtoleranz hinzuzufügen. Sie stellen die max. Aufnahmewerte bei extremen Betriebsbedingungen dar und dienen als Bezug für die Gruppierung mit Bezug für die Gruppierung mit Komponenten.

Ø 900									
	XXLDF		XXLDN		XXLDX		XXLDU		
	6P		6P		8P		12P		
	△	∧	△	∧	△	∧	△	∧	
W	3300	1900	2450	1560	1110	680	310	190	
A	6,30	3,50	5,20	2,90	2,70	1,36	0,83	0,39	

Correzione livello pressione sonora per distanza diversa da 10 m.

Sound pressure level correction for other than 10 m.

Correction niveau pression sonore pour distance différent de 10 m.

Pegeländerung für andere Entfernungen als 10 m.

Corrección de presión Sonora para distancias diferentes de 10 m.

Уровень звукового давления на расстоянии 10 м.

Współczynniki korekcyjne ciśnienia akustycznego dla odległości innej niż 10 m.

XXLD Ø 900

m	2	3	5	10	15	20	30	40	60	80	100
dB (A)	10	8	5	0	-3	-5,5	-8,5	-11	-14	-16	-18

Aumento del livello potenza sonora in funzione del numero dei ventilatori.

Sound power level increasing according to fan number.

Augmentation du niveau puissance sonore selon le nombre des ventilateurs.

Schalleistungspegel in Abhängigkeit von der Ventilatoranzahl.

El nivel de potencia sonora aumenta en función del número de ventiladores.

Увеличение уровня звуковой мощности в зависимости от количества вентиляторов.

Wzrost poziomu mocy akustycznej w zależności od ilości wentylatorów.

XXLD Ø 900								
Ø N°	8	10	12	14	16	18	20	22
dB (A)	+9	+10	+11	+12	+12	+13	+13	+14

I livelli di potenza sonora sono stati provati secondo la norma EN 13487.

Sound power levels are tested according to EN 13487.

Les niveaux de puissance acoustique sont éprouvés selon la norme EN 13487.

Die Schalleistungspegel sind nach EN 13487 Norm geprüft.

Nivel de potencia Sonora comprobado de acuerdo con la norma EN 13487.

Уровни звуковой мощности проверены согласно нормативам EN 13487.

Pomiary poziomu mocy akustycznej zostały wykonane według normy EN 13487.



Datos de placa ventiladores de 400-3ph-50Hz

Estos datos deben sumarse a los valores indicados como standard, y son los valores máximos de consumo bajo las condiciones más agresivas, y sirven como referencia para calcular las otras componentes eléctricas que no sean suministradas por LU-VE.

Характеристики с этикетки двигателей 400V- 3PH- 50HZ

эти данные, принимают в расчёт нормативный запас отклонения, указывают макс. значения энерг. расхода при самых тяжёлых условиях работы и являются ссылкой для подбора электрических компонентов не поставляемых фирмой LU-VE.

Dane elektryczne dla wentylatorów 400V-3F-50Hz

Aby uzyskać wartości maksymalne poboru mocy, należy do poniższych wartości, dodać wyspecyfikowane w normach wskaźniki tolerancji. Wartości maksymalne występują w szczególnie trudnych warunkach pracy po zastosowaniu komponentów nie występujących w produktach LU-VE.



EHL *Giants*

**Dry cooler with regulation,
EC fans and Spray System**
Steam turbine water cooler
North East England



EHL *Giants*

Dry coolers with regulation
Air conditioning installation
Bolshoi Theatre, Moscow, Russia



EHL *Giants*

Dry coolers with Spray System
Turbine cooling installation for the production
of electricity
Hannover, Germany



XXLDX *Mega Giants*

Dry coolers with EC fans and *The Whisperer*[®]
Air conditioning installation
Free Provider, Paris, France



EHL D *Giants*

Dry coolers fitted with water-softening plant
Conditioning and cooling of process water for the
production of electronic components
Trane for Swatch, Marin, Switzerland



SHLD *Giants*

Dry coolers with Spray System
Air conditioning installation
Frankfurt exhibition centre (Hall 4), Germany



LU-VE S.p.A.

Via Caduti della Liberazione, 53

21040 Uboldo (Va)

Tel: +39 02 96716.1

e-mail: sales@luvegroup.com

www.luve.it